

A	B	C	D	
1	S426-1023	354	800	1/1
2	S426-1024	354	150	1/1
3	S426-2017	1100	600	1/1
4	S426-2018	1100	600	1/1
5	S426-4029	1098	100	1/1
6	S426-4030	568	100	1/1
7	S426-4031	940	60	1/1
8	S426-4032	404	60	1/1

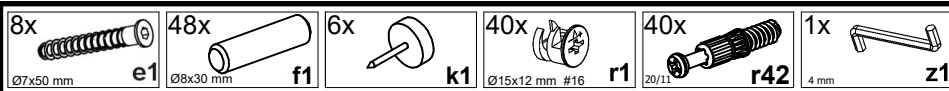

1 

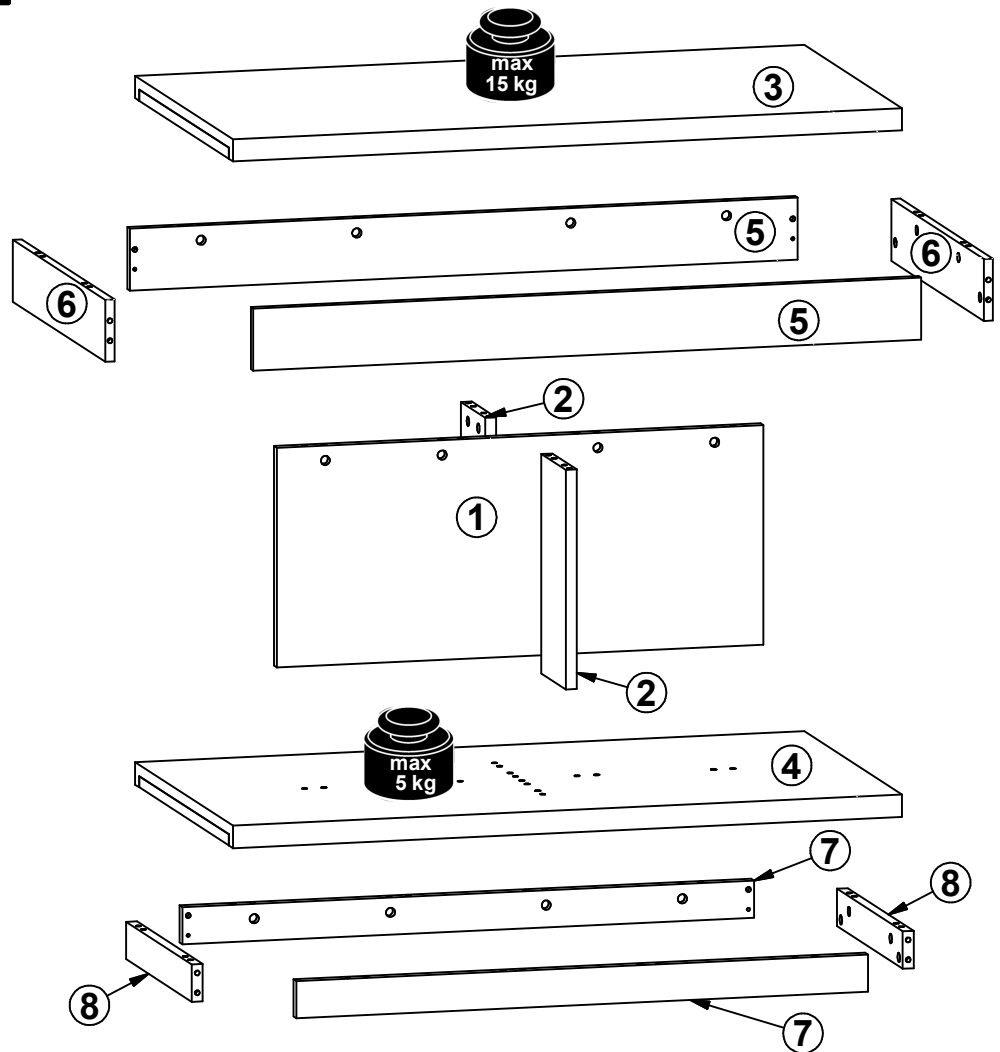
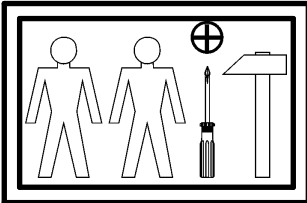
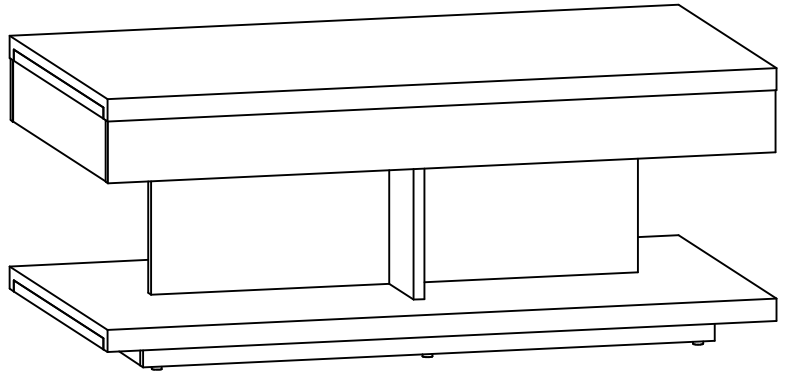
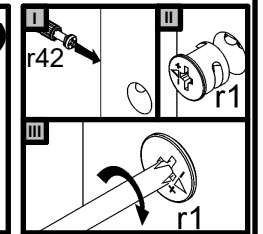
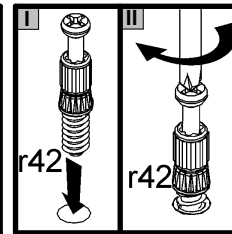
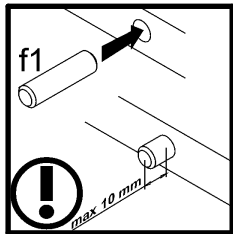
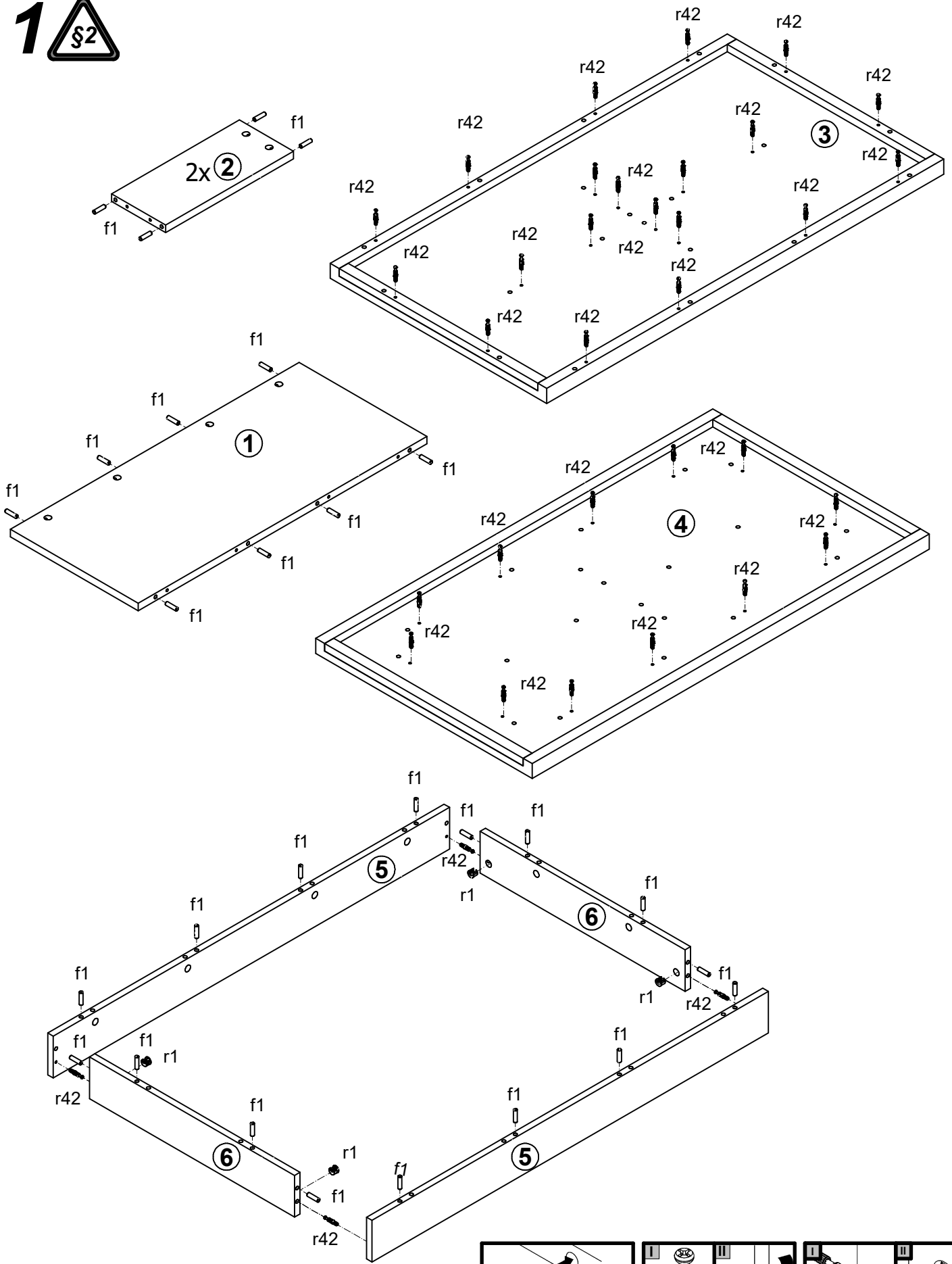

2

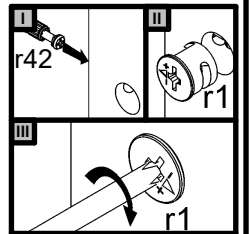
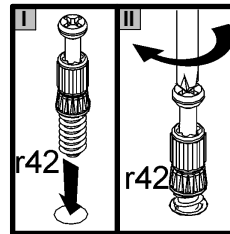
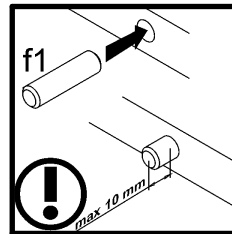
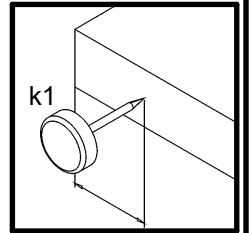
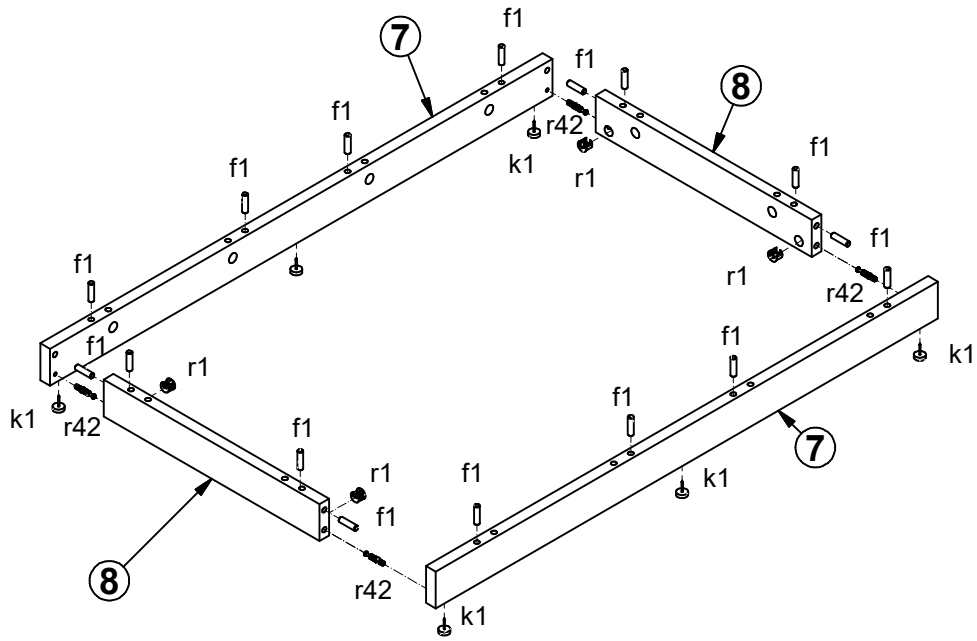

3

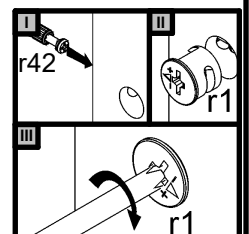
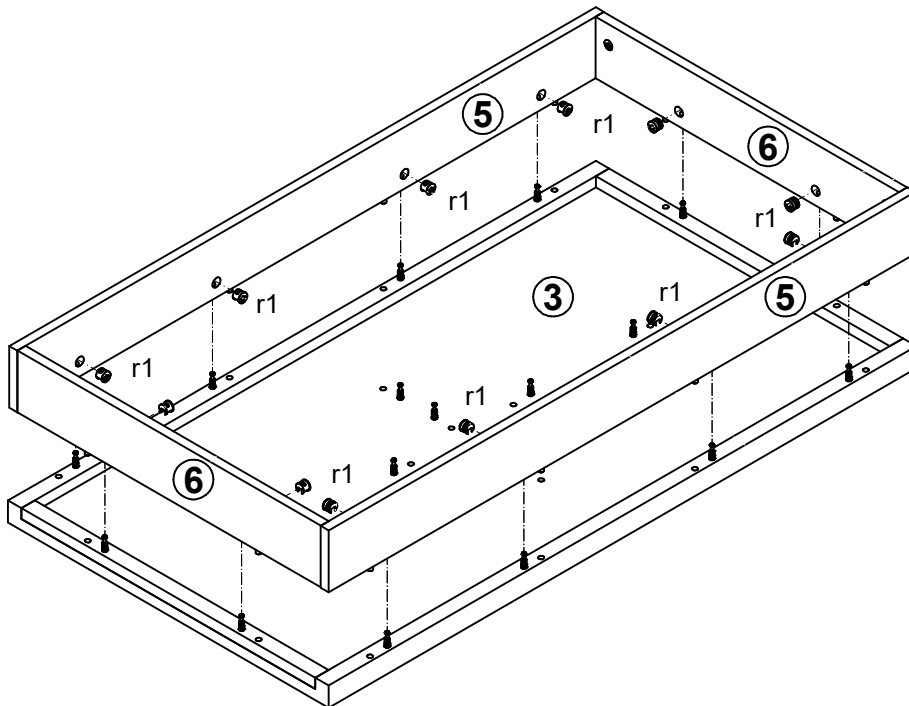

4

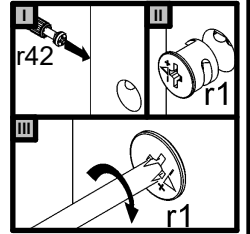
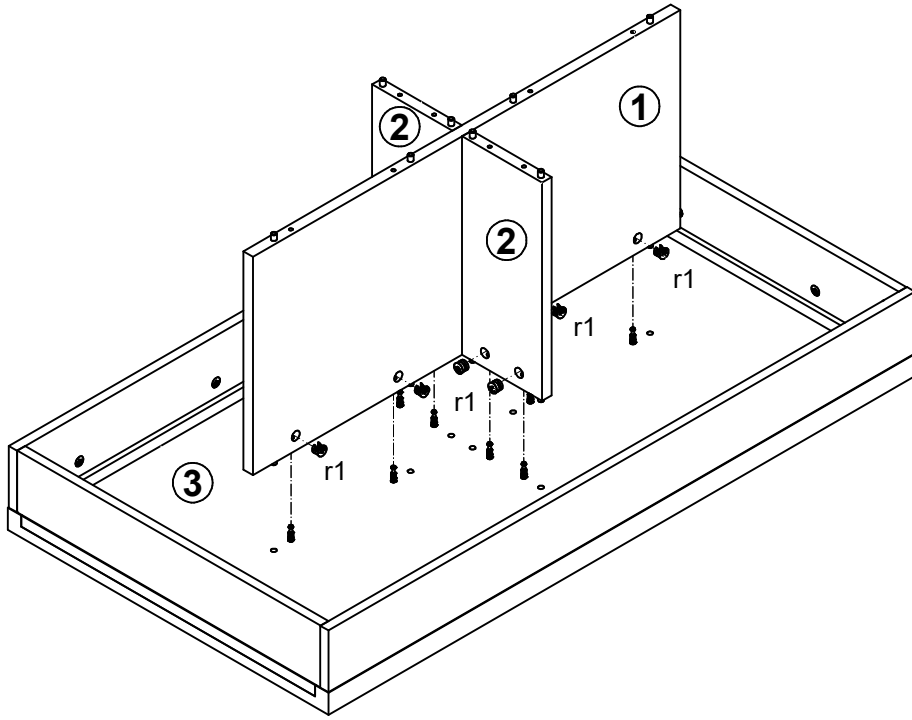

5

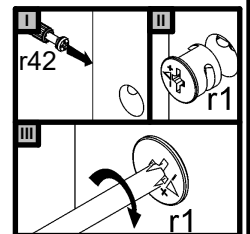
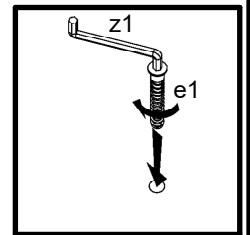
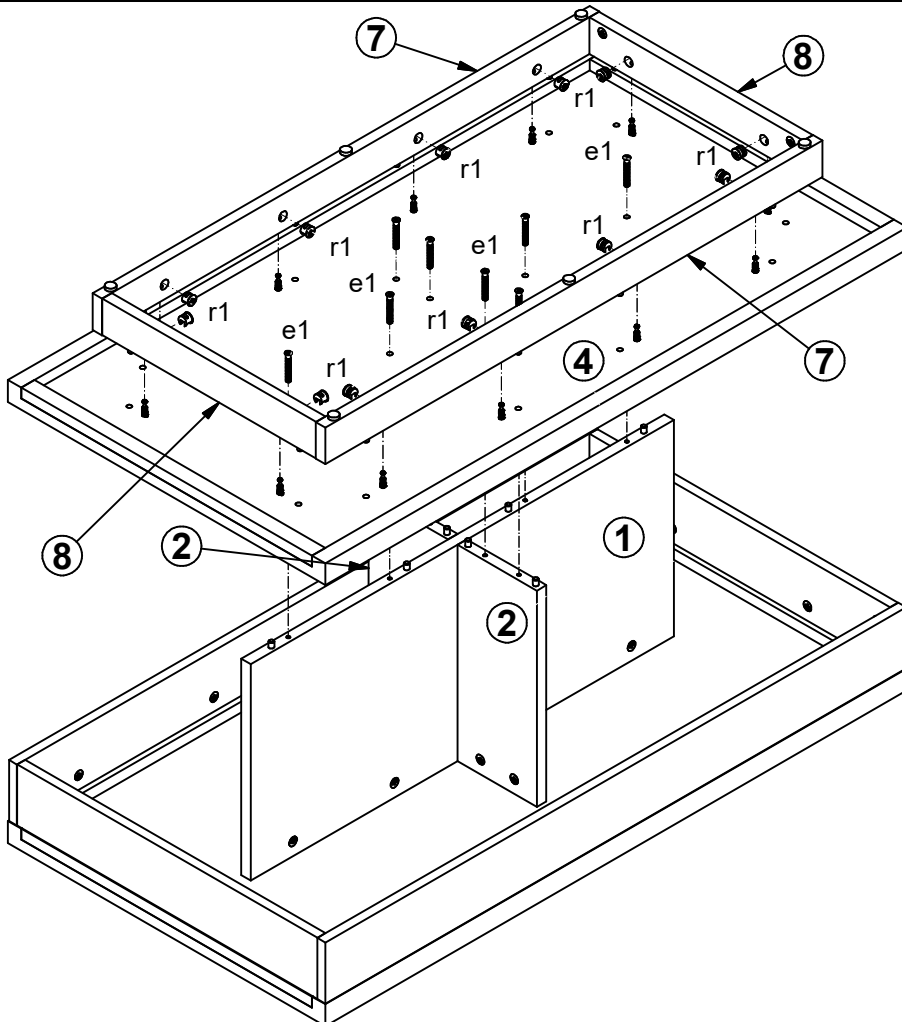

6

