

# GAMEING

# B24-BIU/140

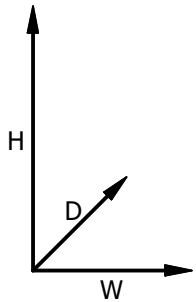

H - 752 mm  
W - 1380 mm  
D - 680 mm

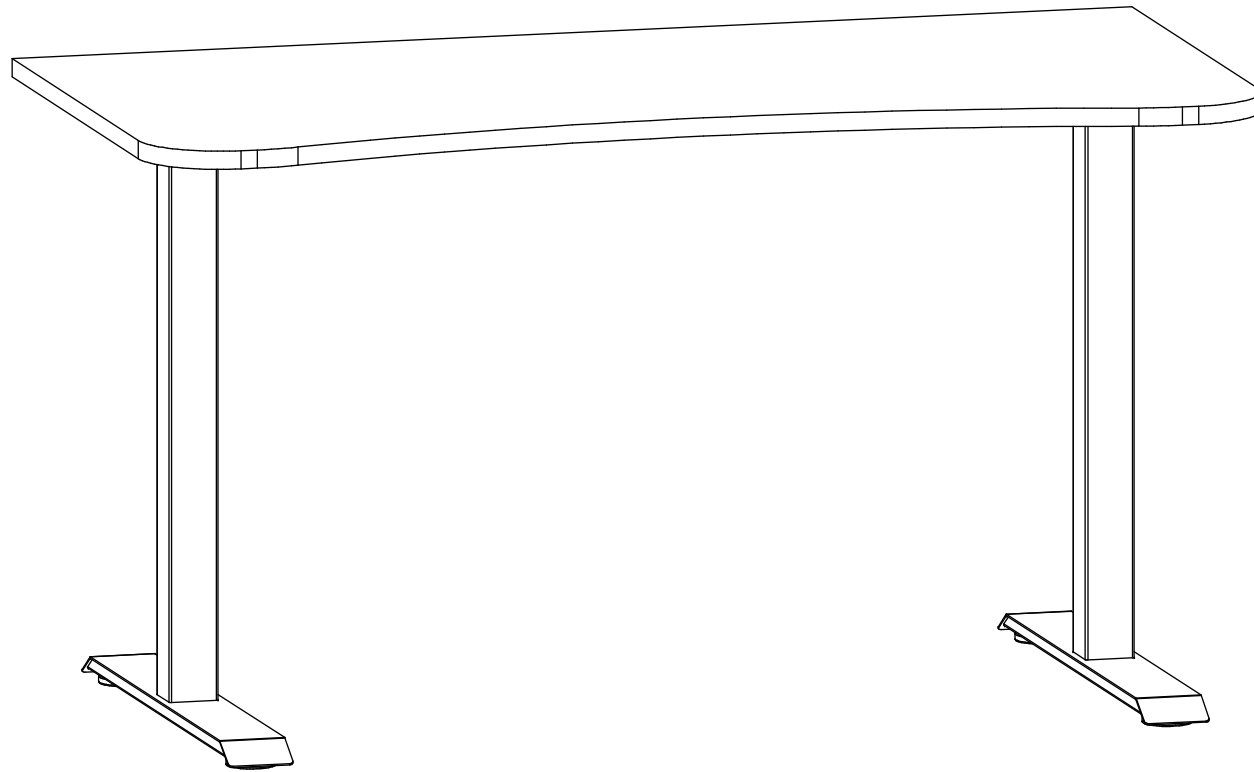
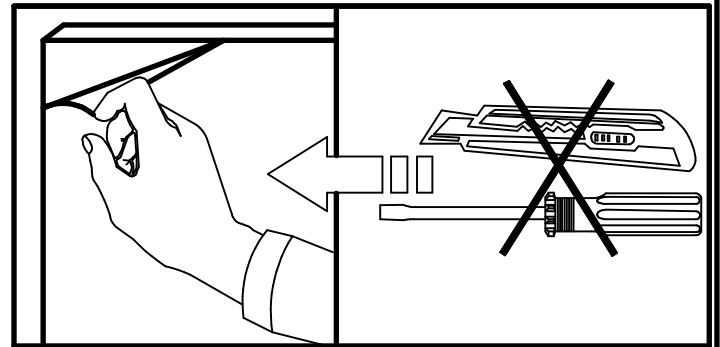
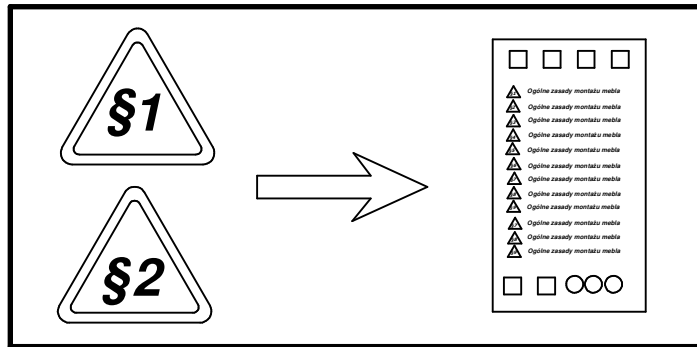
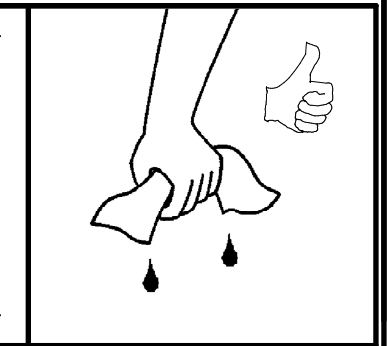
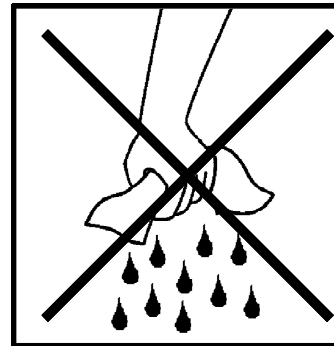
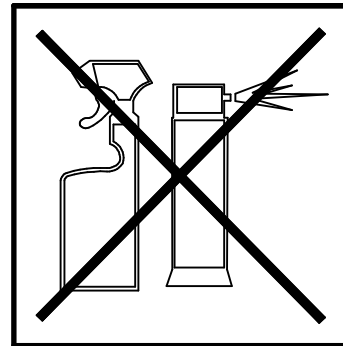
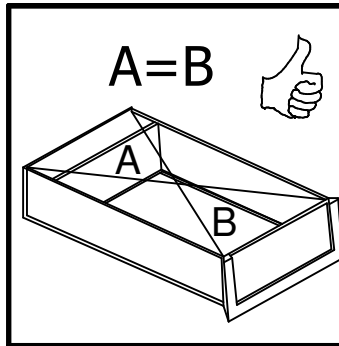
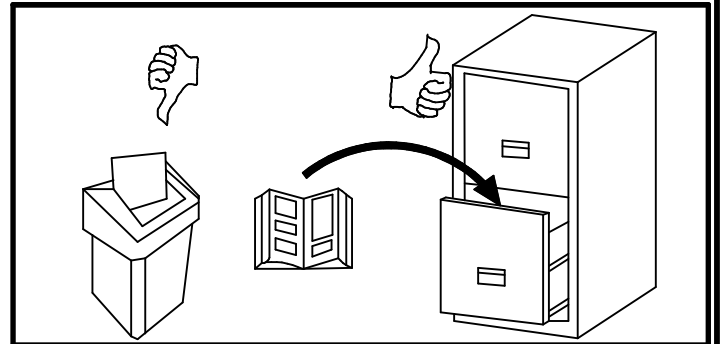
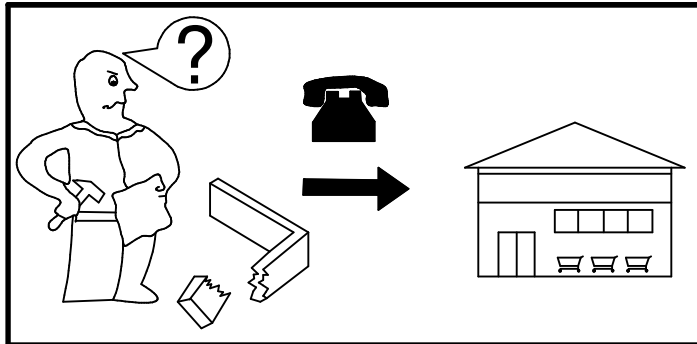
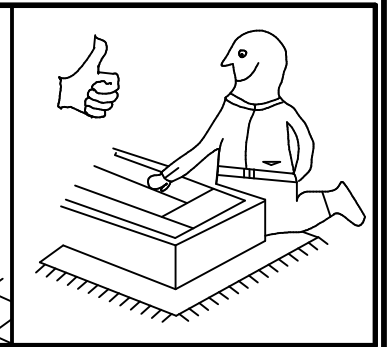
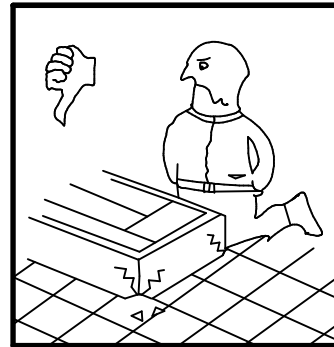
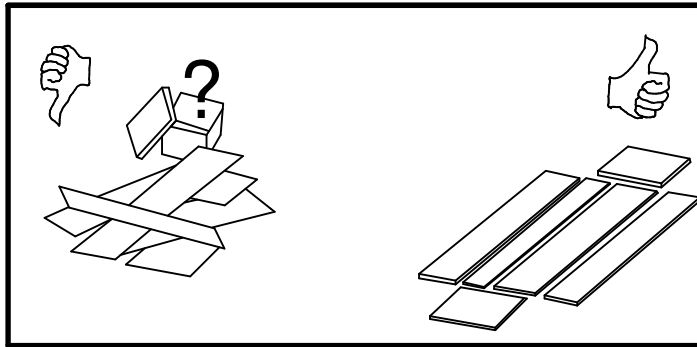
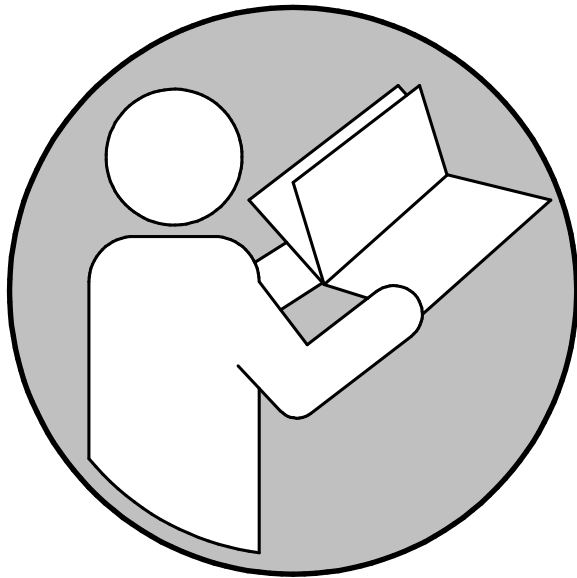

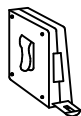
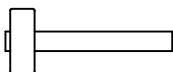
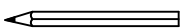
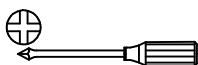
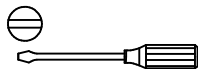
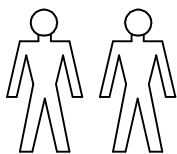



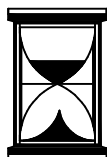
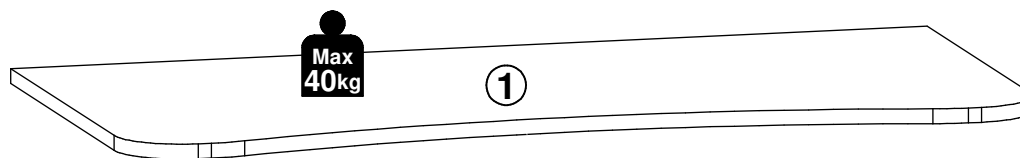

A	B	C (mm)			D
1	B24-2001	1380	680	22	1/3

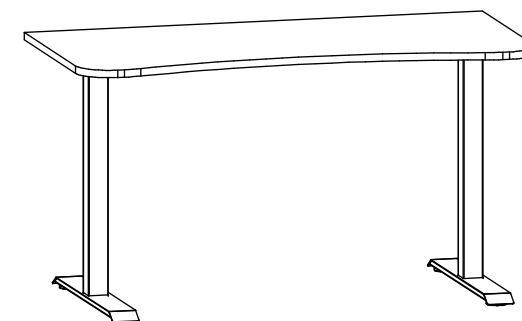

20 min



D
2/3, 3/3

- 8x  e7  
Ø6.3x16 mm
- 4x  j133  
M6x20 mm
- 2x Noga metal h=730/740 czarny mat k151\1
- 4x Stopka plastik/metal wkręcana z gwintem M10x15 czarny R&S k151\2
- 1x Poprzeczka - reling metal L-1069 czarny mat k151\3
- 18x  p39  
Ø4x20 mm
- 1x  z1  
4 mm

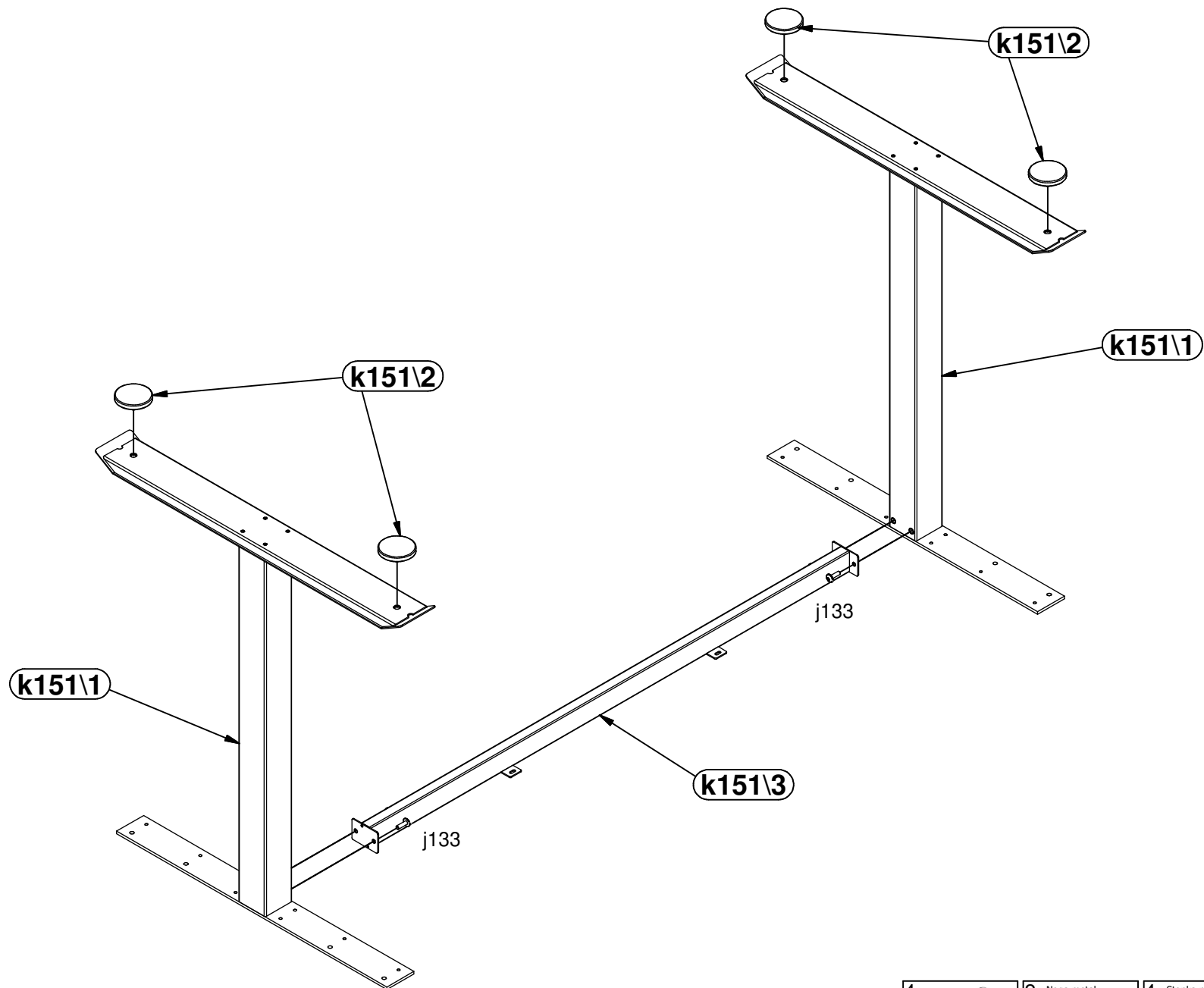

1 

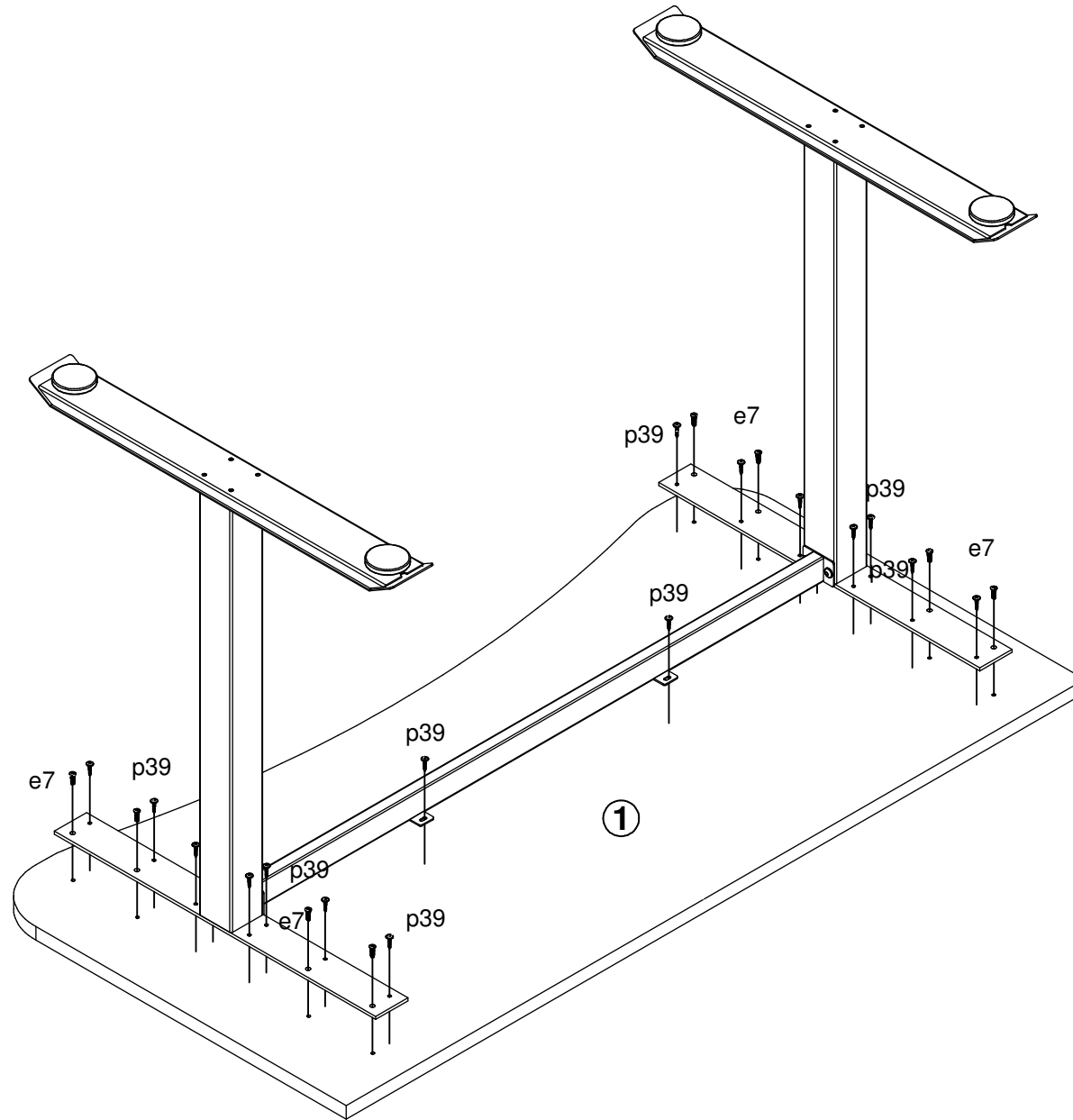

4x  M6x20 mm <b>j133</b>	2x Noga metal h=730/740 czarny mat <b>k151\1</b>	4x Stopka plastik/metal wkrecana z gwintem M10x15 czarny R&S <b>k151\2</b>	1x Poprzeczka - reling metal L-1069 czarny mat <b>k151\3</b>
--	---	---	---

2 



8x  e7	18x  p39	1x  z1
Ø6.3x16 mm	Ø4x20 mm	4 mm