

ZENDA

S617-REG1D1W

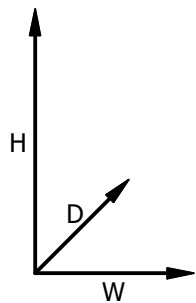

H - 1943 mm
W - 901 mm
D - 415 mm

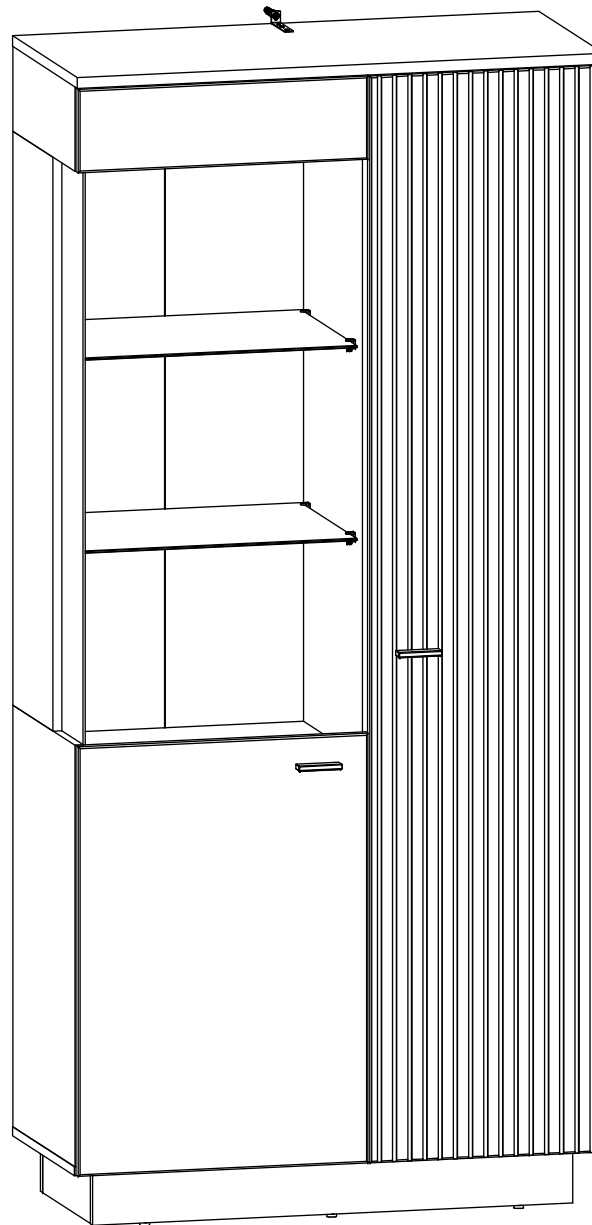
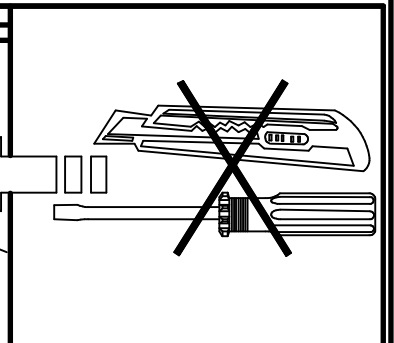
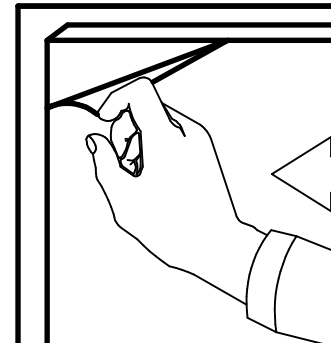
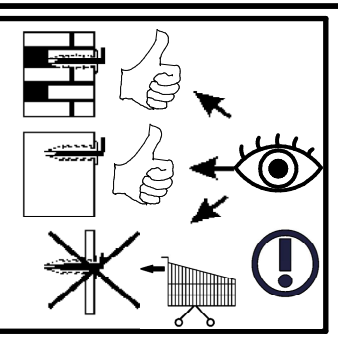
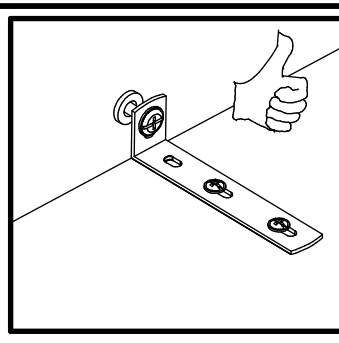
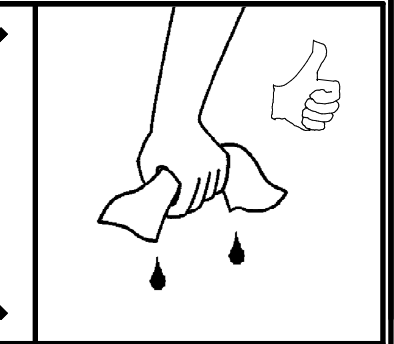
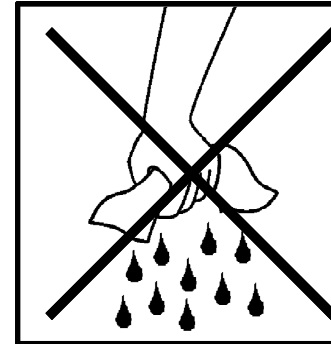
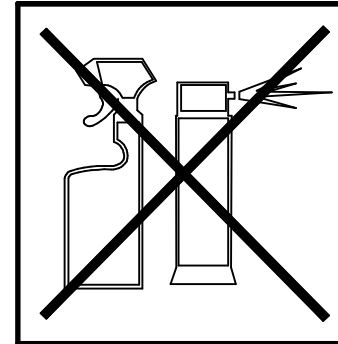
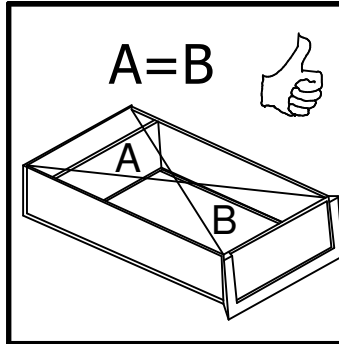
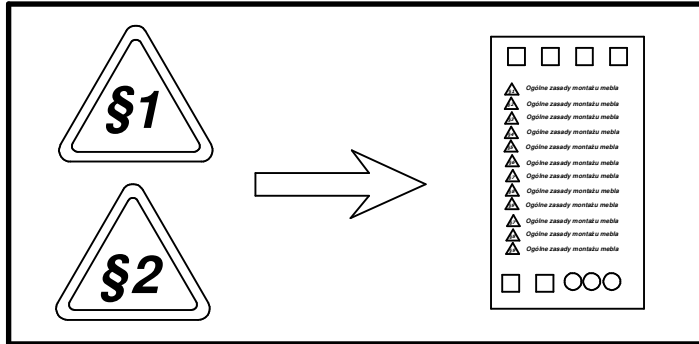
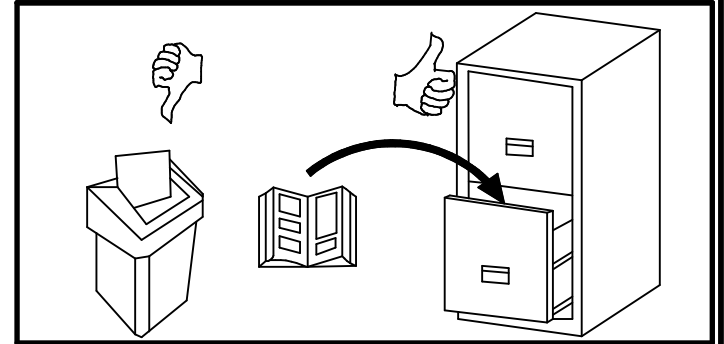
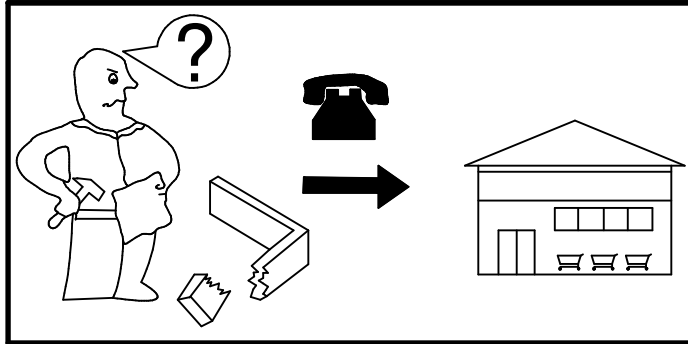
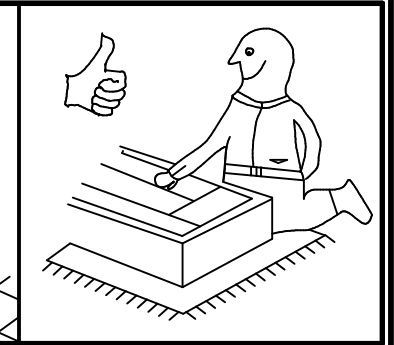
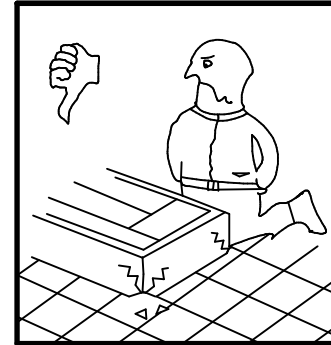
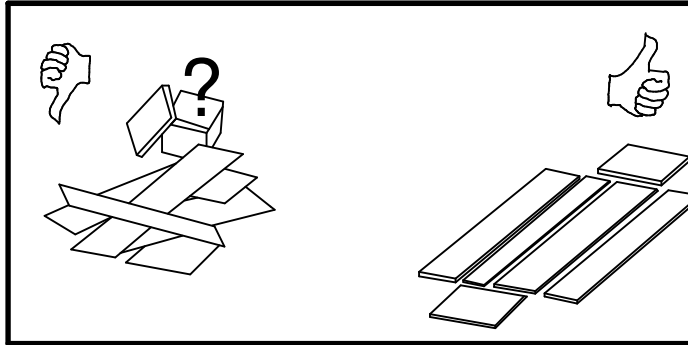
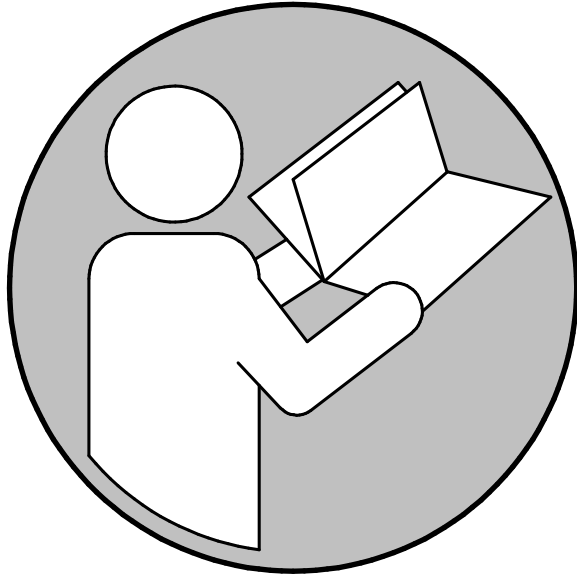

Ø10mm

1 h

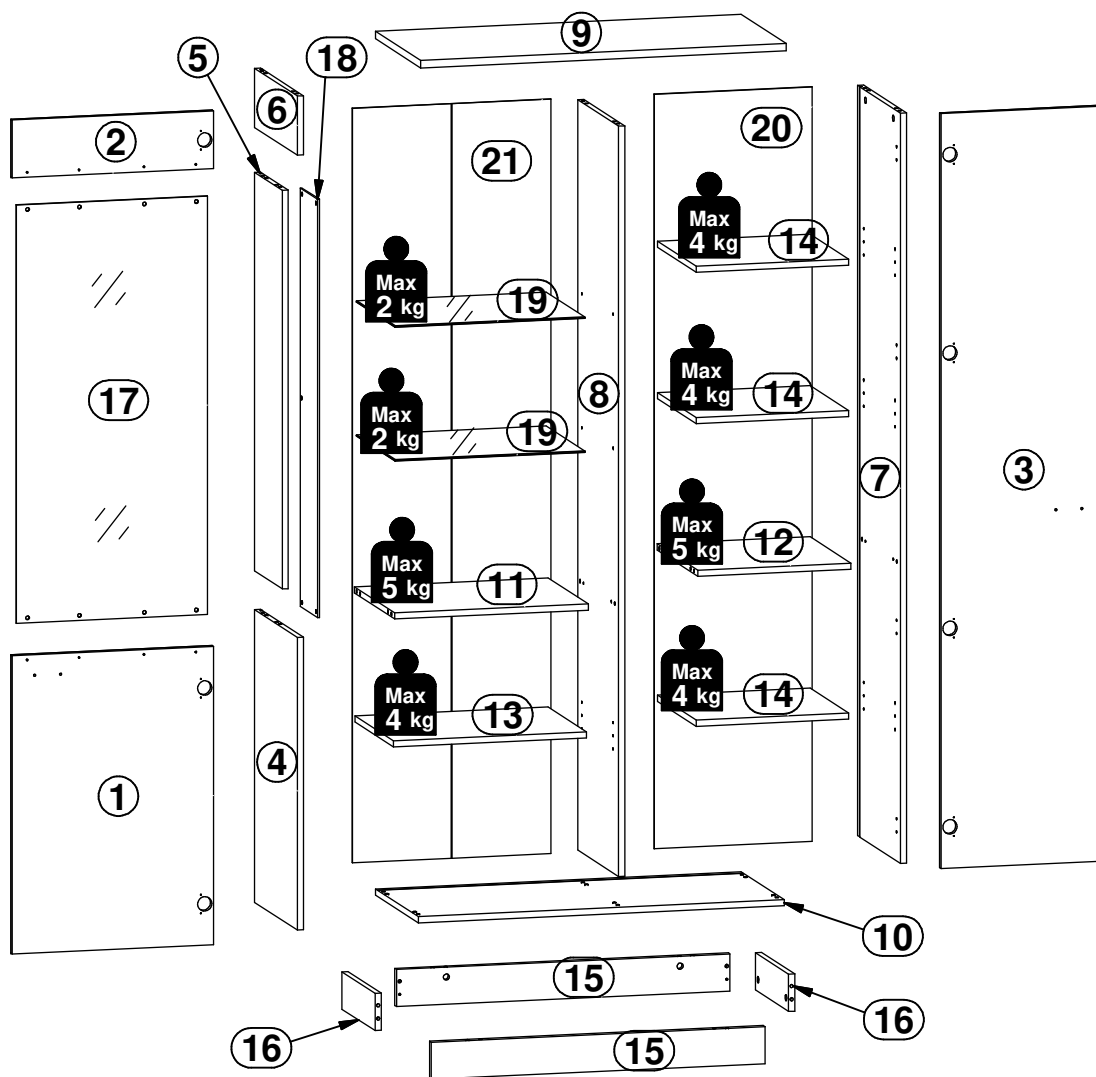



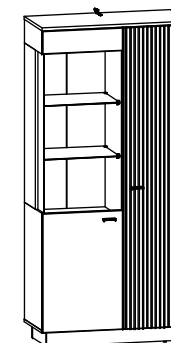



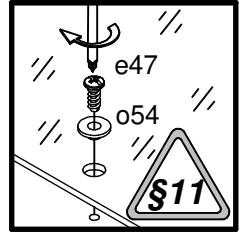
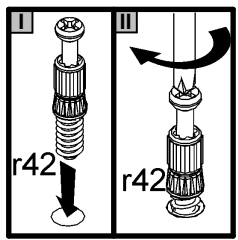
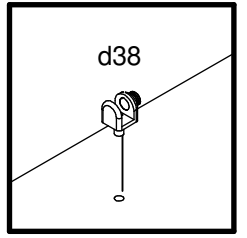
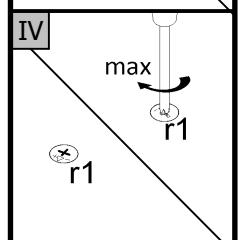
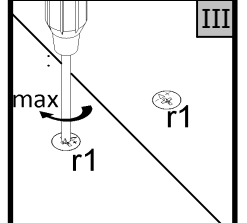
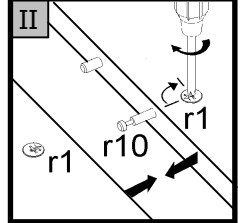
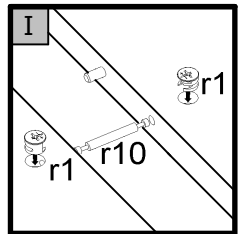
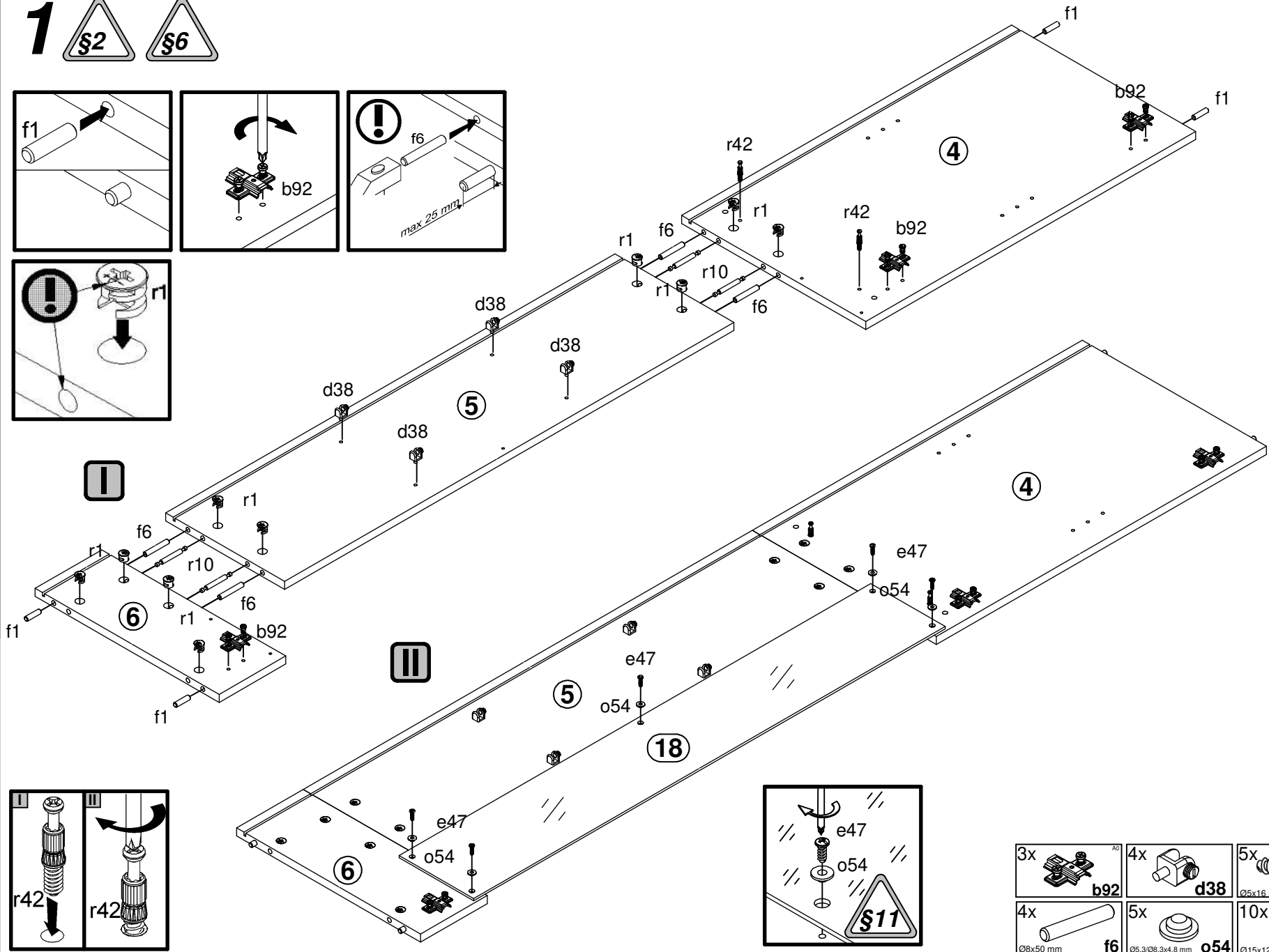
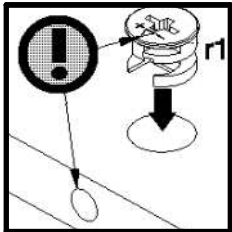
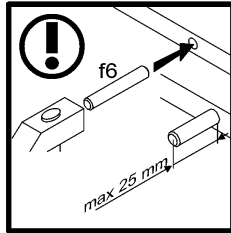
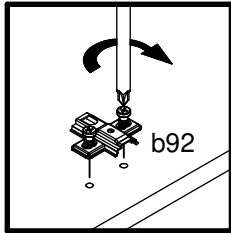
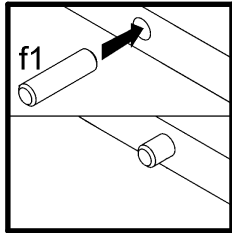

A	B	C (mm)			D
1	S617-0002	722	496	16	3/4
2	S617-0003	140	496	16	3/4
3	S617-0101	1826	396	16	2/4
4	S617-1001	708	395	15	1/4
5	S617-1002	964	255	15	1/4
6	S617-1003	143	395	15	1/4
7	S617-1004	1815	395	15	1/4
8	S617-1005	1815	375	15	2/4
9	S617-2001	901	415	18	3/4
10	S617-2002	901	395	15	3/4
11	S617-3001	477	370	15	3/4
12	S617-3002	377	375	15	3/4
13	S617-3003	476	355	15	3/4
14	S617-3004	376	355	15	3/4
15	S617-4001	822	90	15	3/4
16	S617-4002	305	90	15	3/4
17	S617-5001	1012	471	4	4/4
18	S617-5002	1012	160	4	4/4
19	S617-5003	469	355	4	3/4
20	S617-9001	1825	389	2,5	1/4
21	S617-9301	1825	489	2,5	1/4



7x a204	7x b92	2x c491	16x d1	cm 0 1 2 3 4 5 6 7 8 9 10						8x d38	6x e1	13x e47	D 3/4
28x f1	1x f35	4x f6	4x j30	6x k1	14x l2	9x n108	1x n142	13x o54	1x p17	16x p51	9x p55	30x r1	
4x r10	22x r42	14x s68	1x z1										



1  



3x  b92	4x  d38	5x  e47 Ø5x16 mm	4x  f1 Ø8x30 mm
4x  f6 Ø8x50 mm	5x  o54 Ø5.3/Ø8.3x4.8 mm	10x  r1 Ø15x12 mm #16	4x  r10

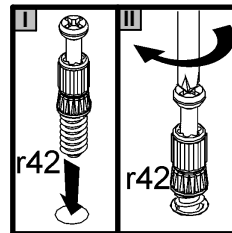
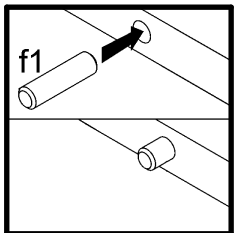
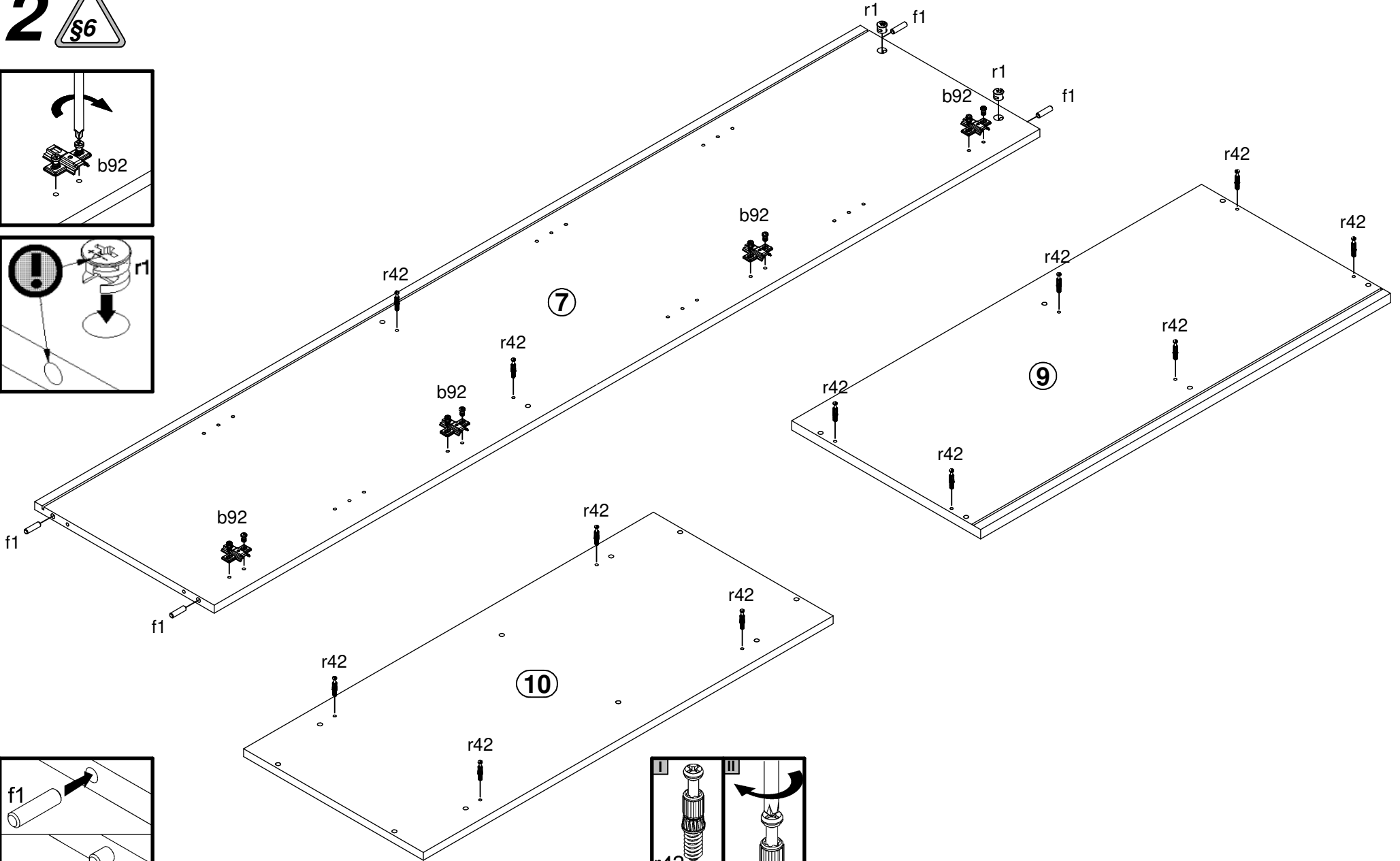
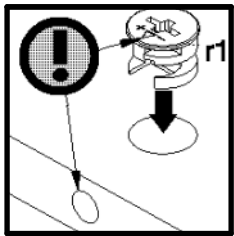
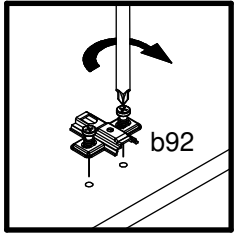

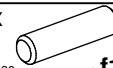

2 

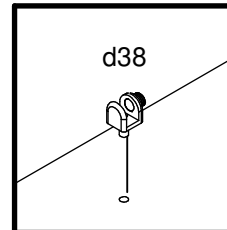
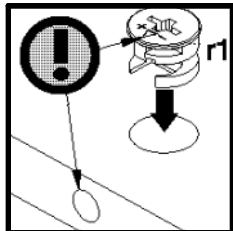
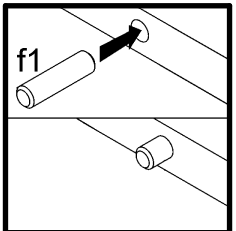
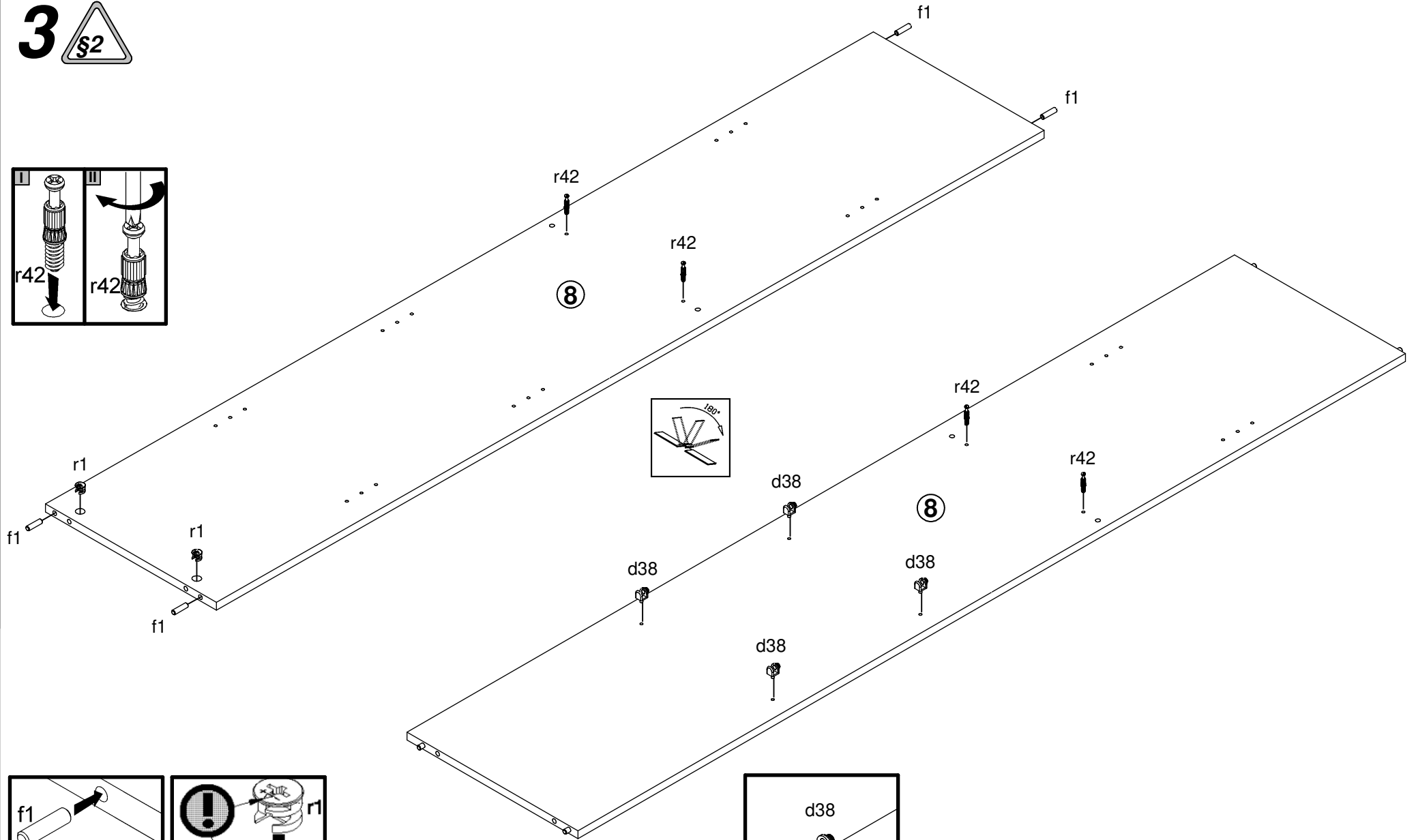
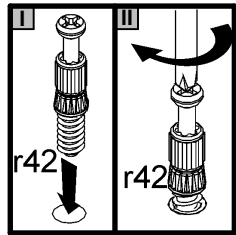

4x  b92	4x  f1 Ø8x30 mm	2x  r1 Ø15x12 mm #16	12x  r42 20/11
-----------------------------------------------------------------------------------------------------	----------------------------------------------------------------------------------------------------------------	---------------------------------------------------------------------------------------------------------------------	---------------------------------------------------------------------------------------------------------------

3 



- 4x  **d38**
- 4x  **f1**
Ø8x30 mm
- 2x  **r1**
Ø15x12 mm #16
- 4x  **r42**
20/11

4 

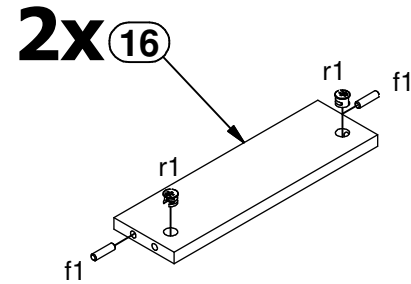
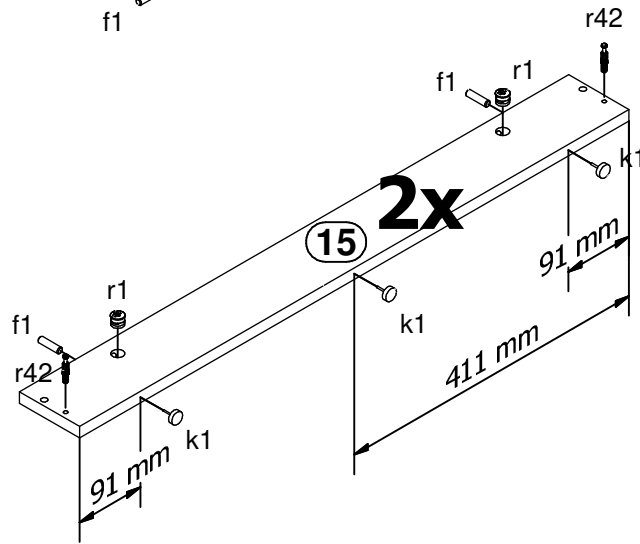
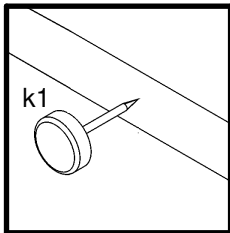
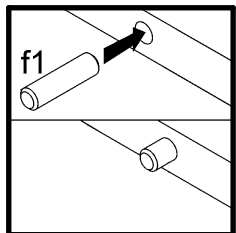
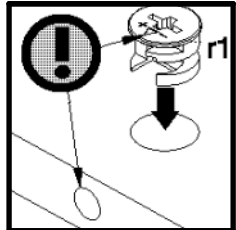
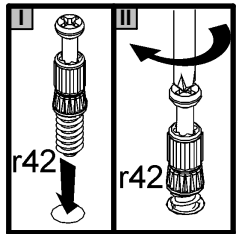
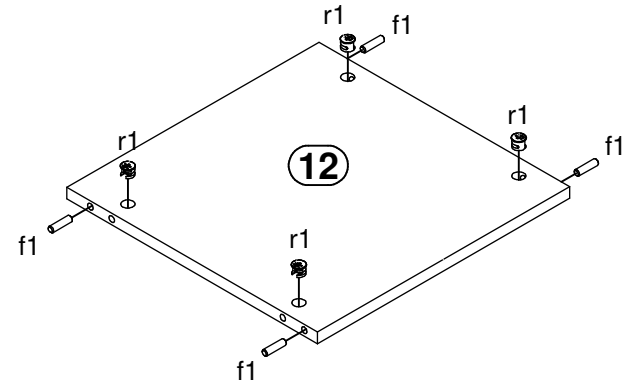
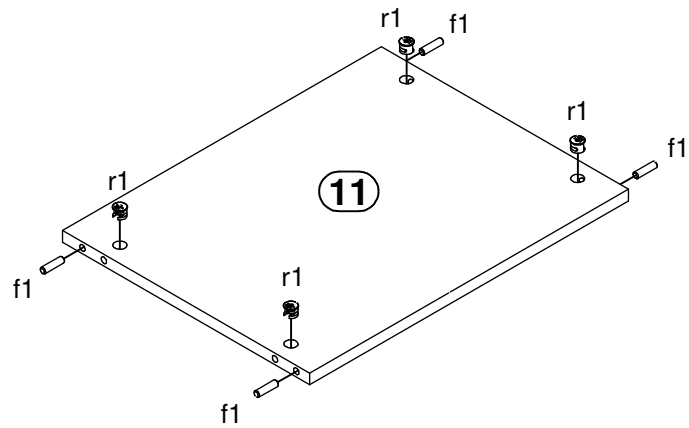

- | | | | |
|-----------------------|----------|----------------------------|-----------|
| 16x
Ø6x30 mm
f1 | 6x
k1 | 16x
Ø15x12 mm #16
r1 | 4x
r42 |
|-----------------------|----------|----------------------------|-----------|

5 

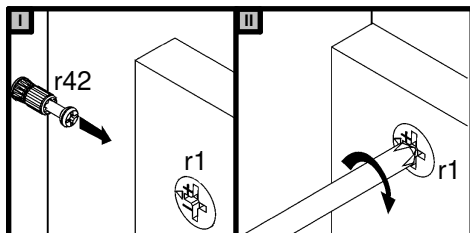
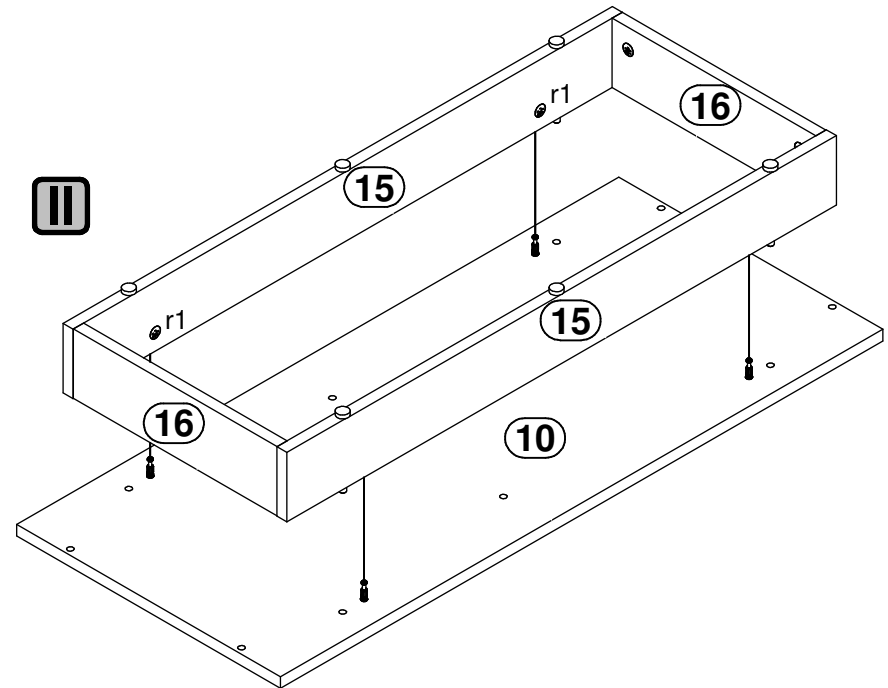
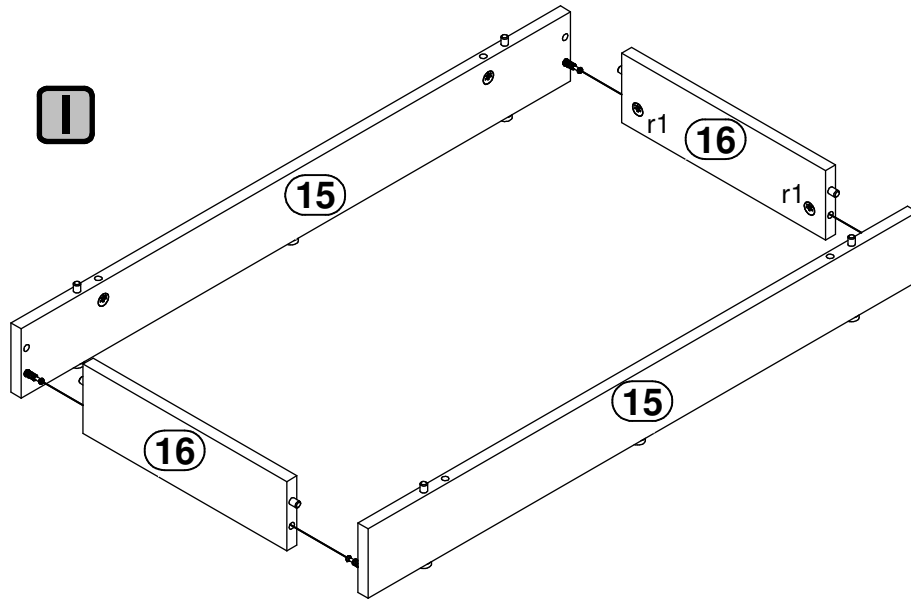

6 

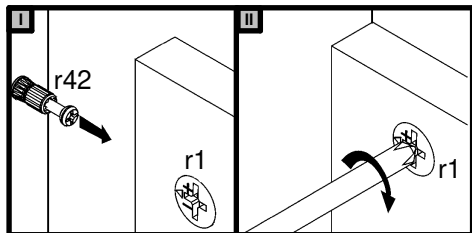
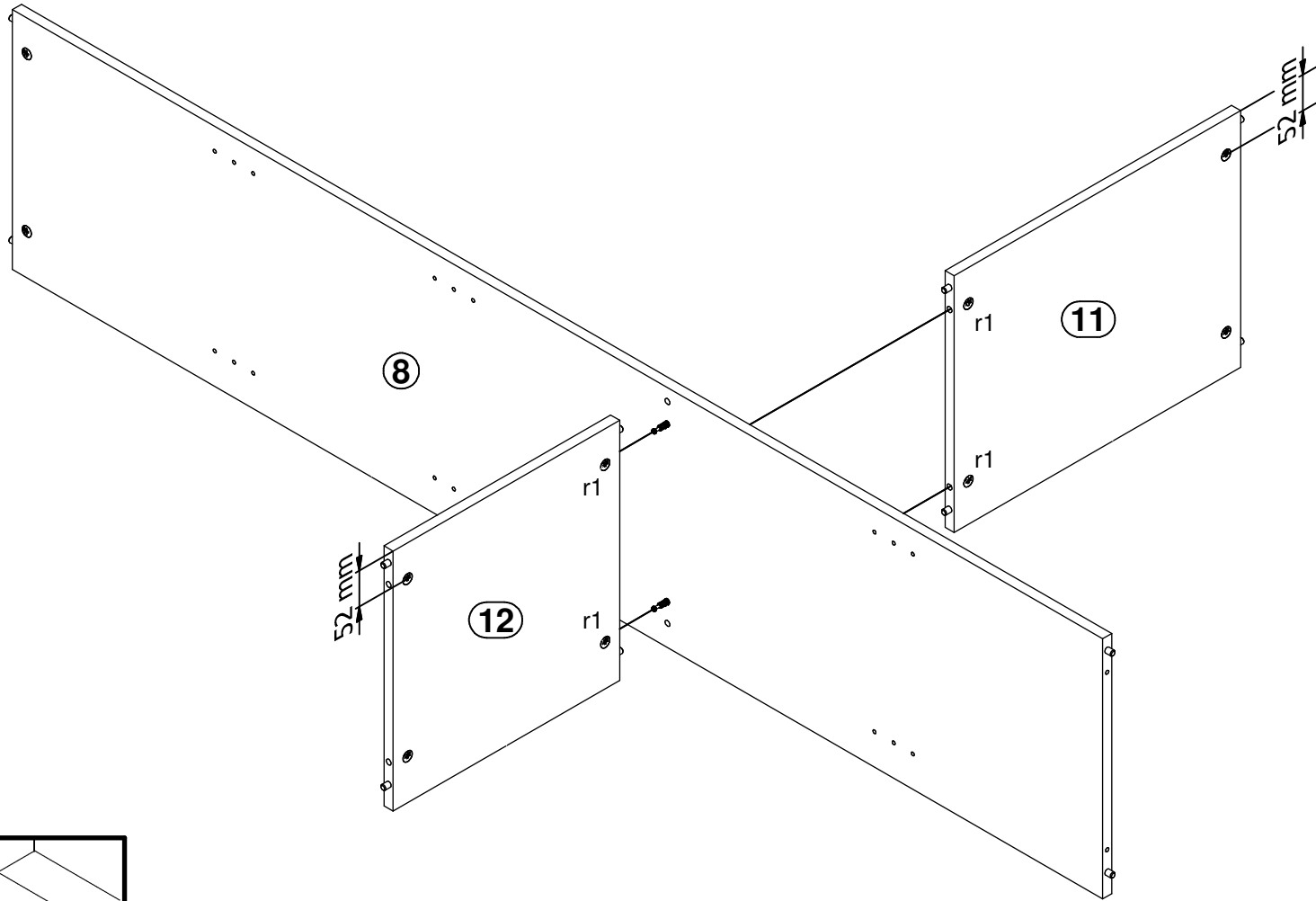

7 

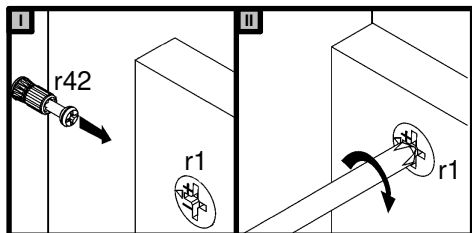
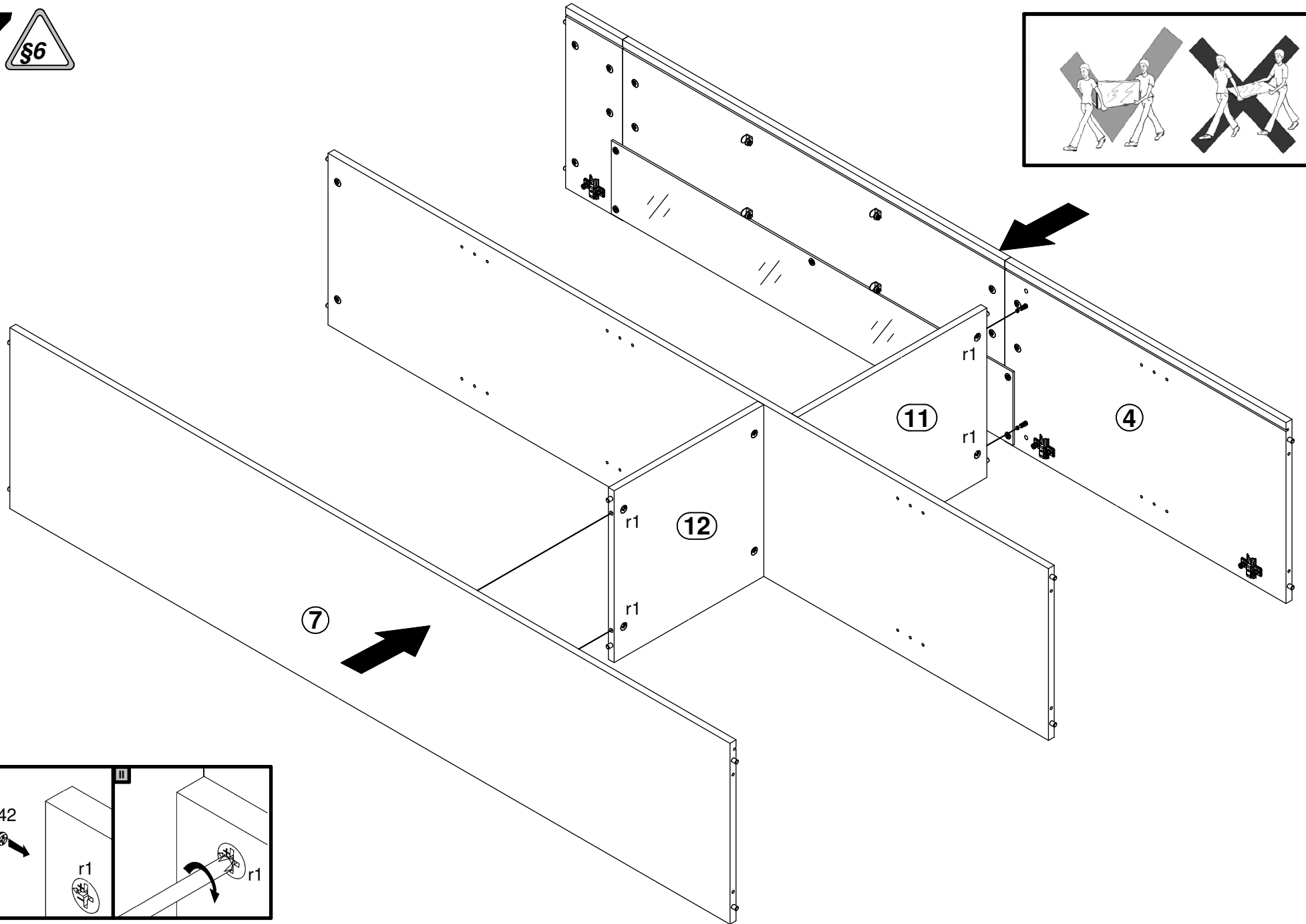
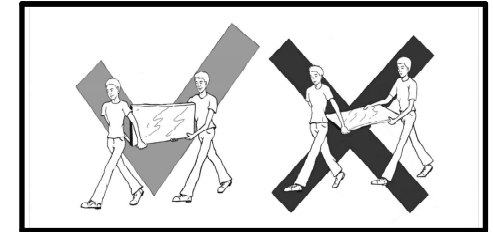

8 

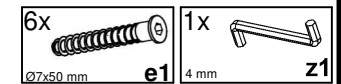
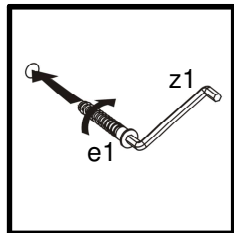
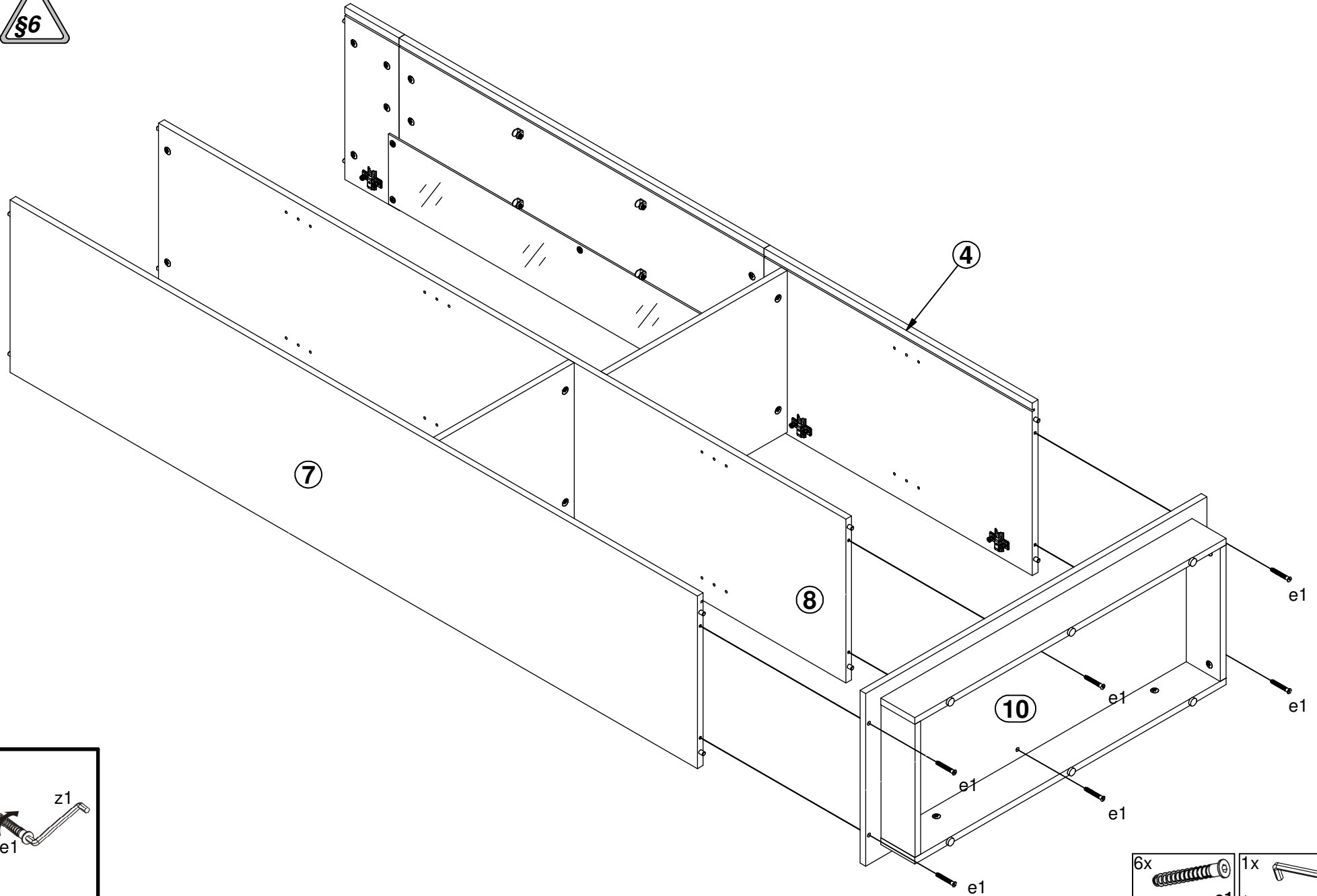

9 

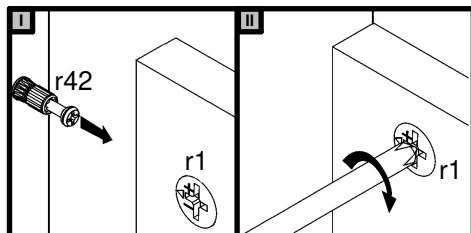
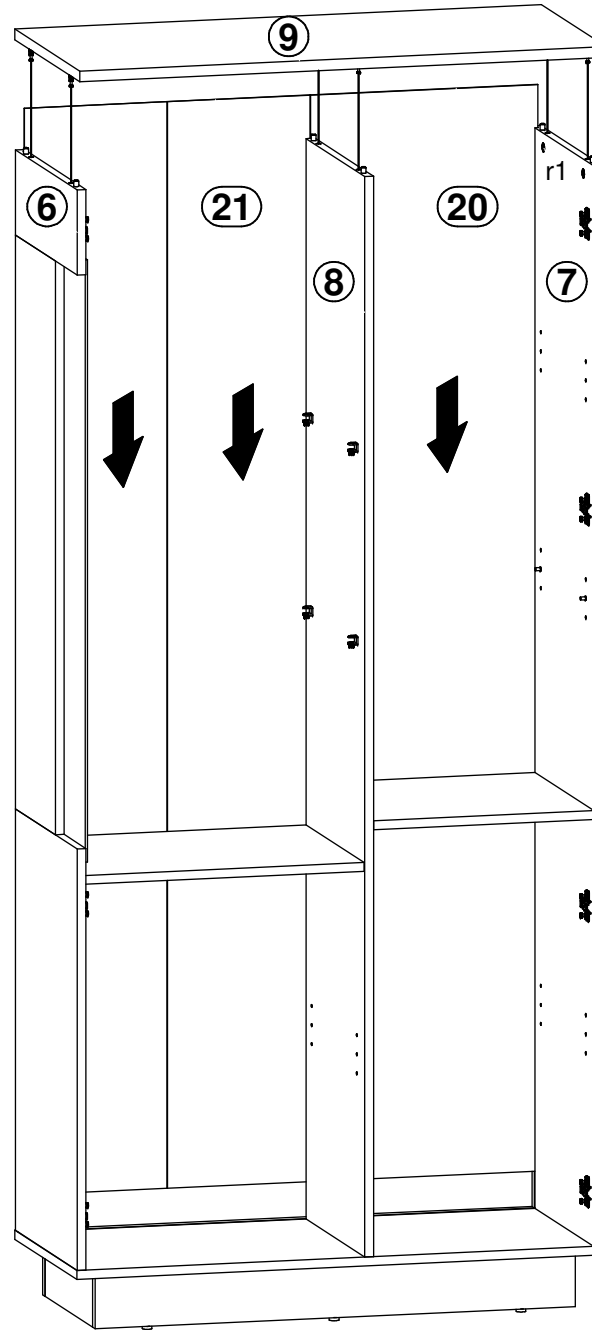

10 

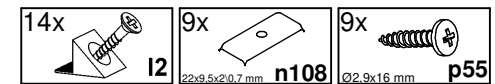
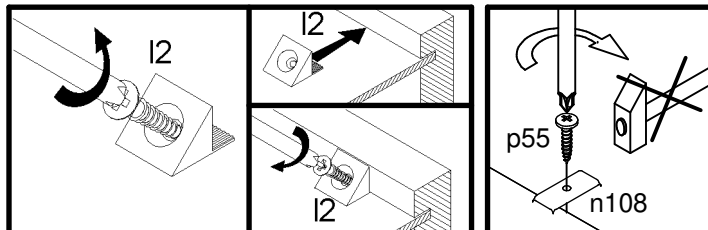
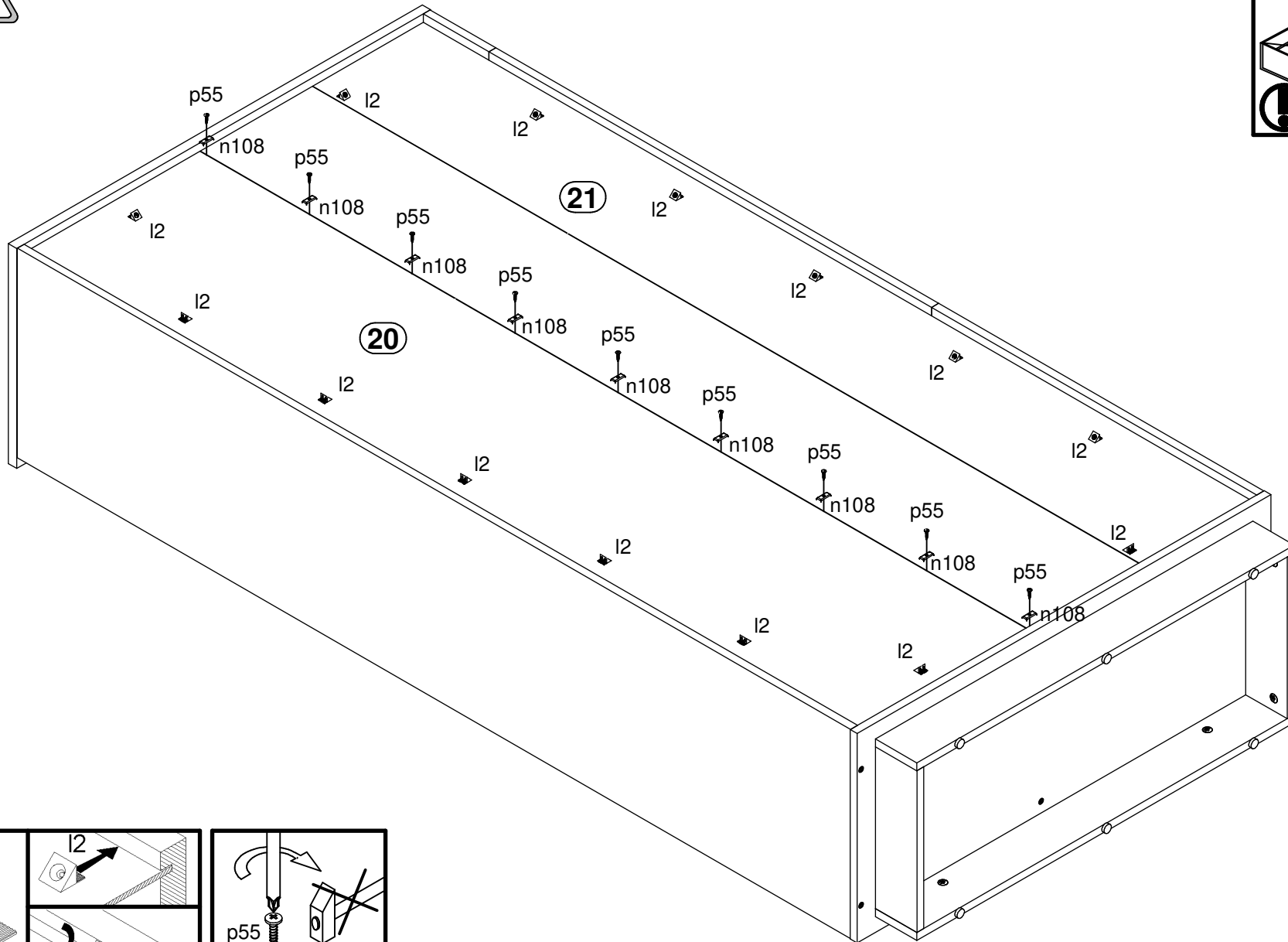
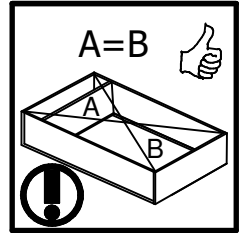

11

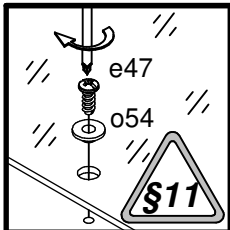
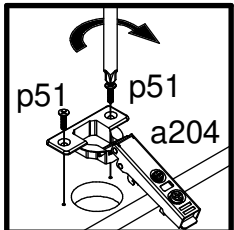
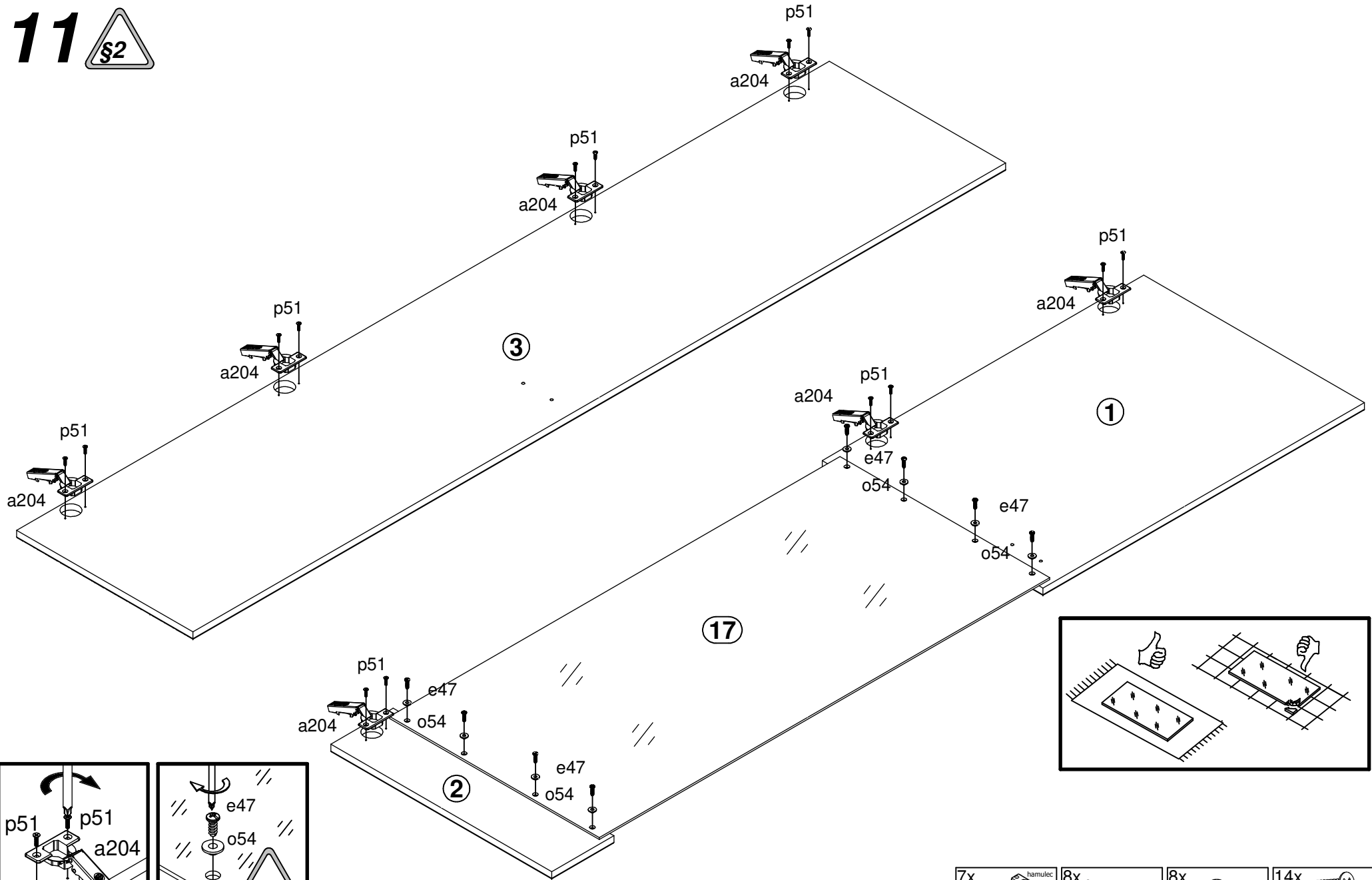

- 7x hamulec a204
- 8x e47
- 8x o54
- 14x p51

12 

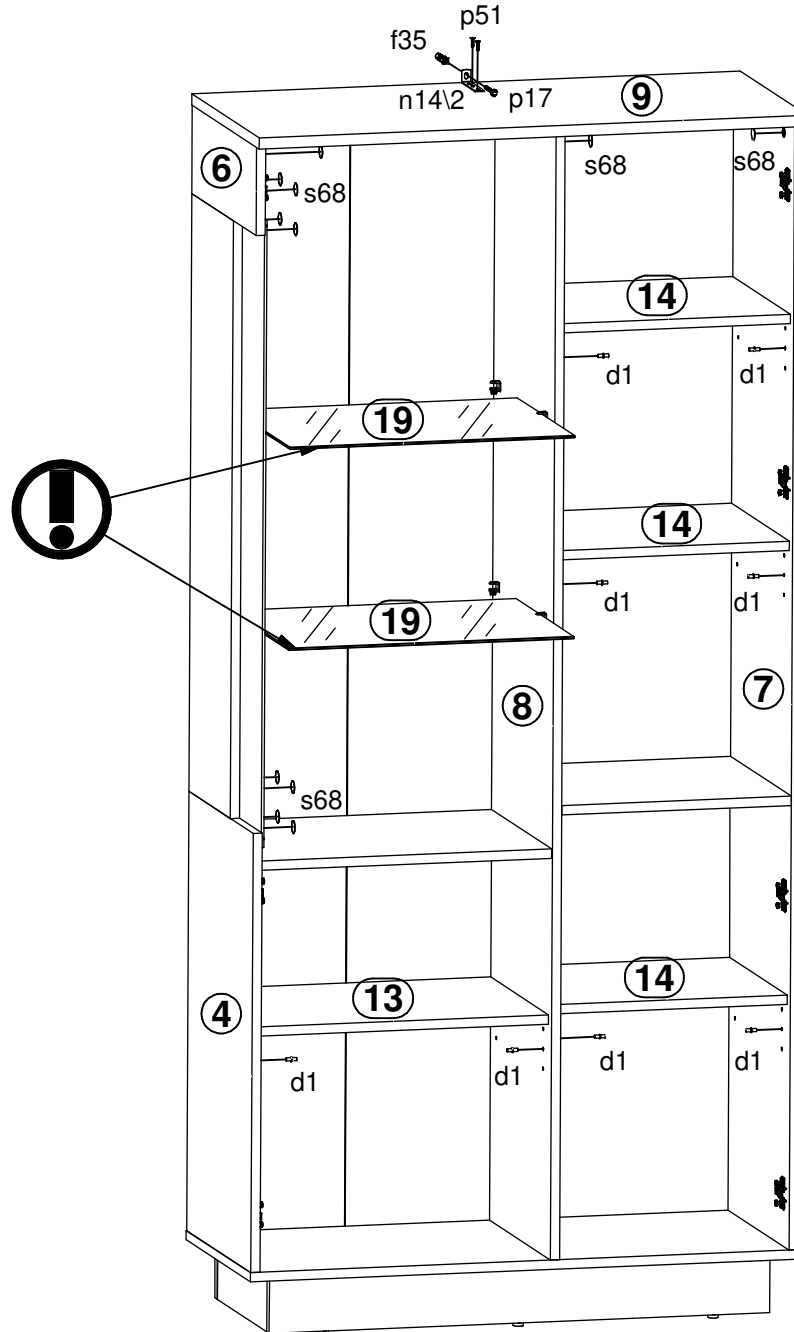
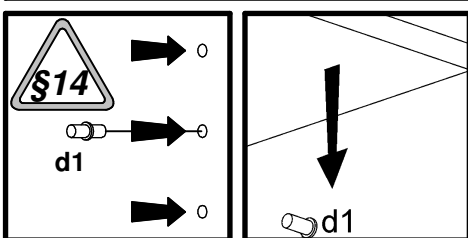
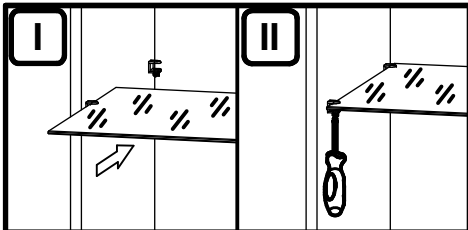
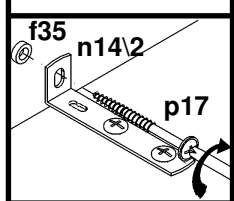
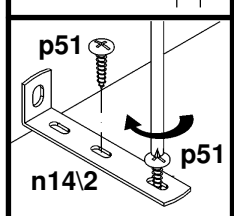
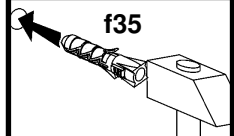
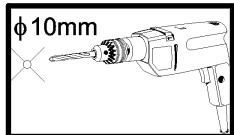

16x Ø5x17 mm	d1	1x Ø10x50 mm	f35	1x 86x21x15/1.5	n142
1x Ø5x60 mm	p17	2x Ø3.5x15 mm	p51	14x Ø 20mm	s68

13

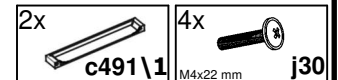
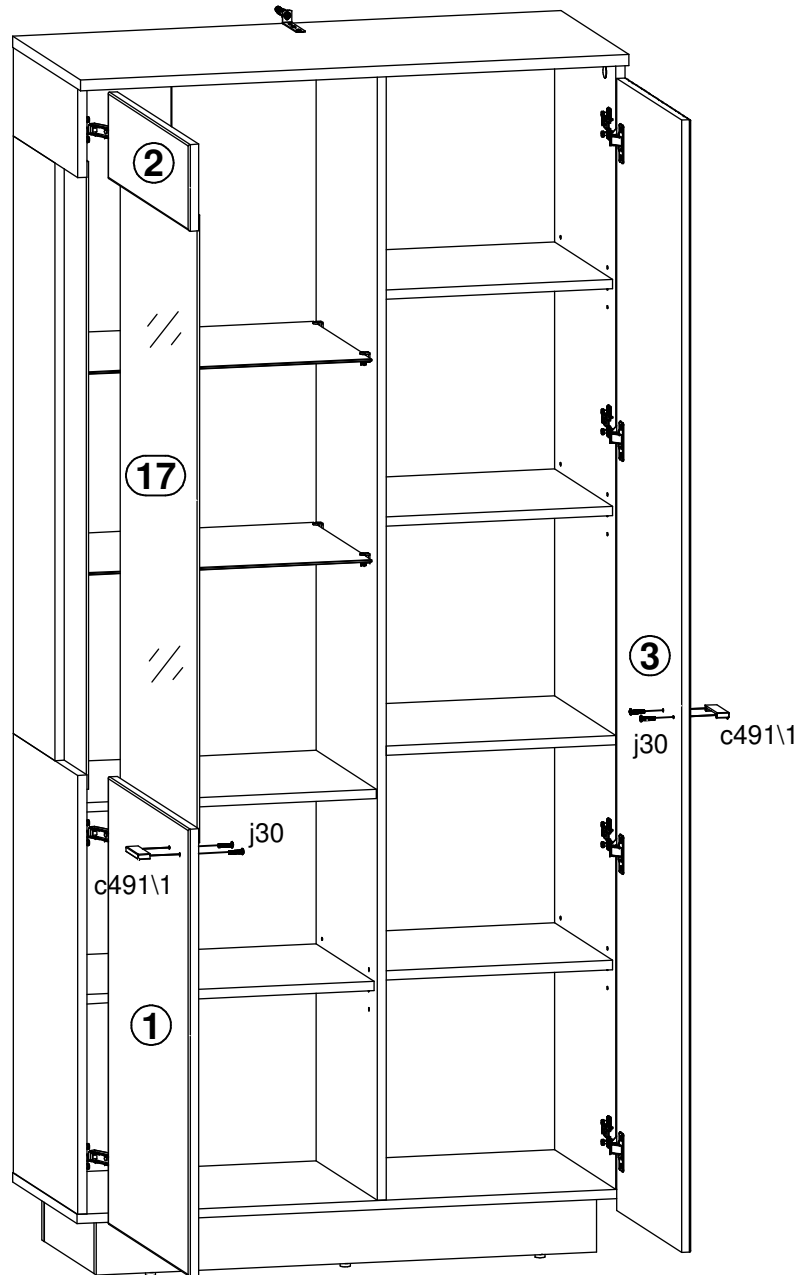
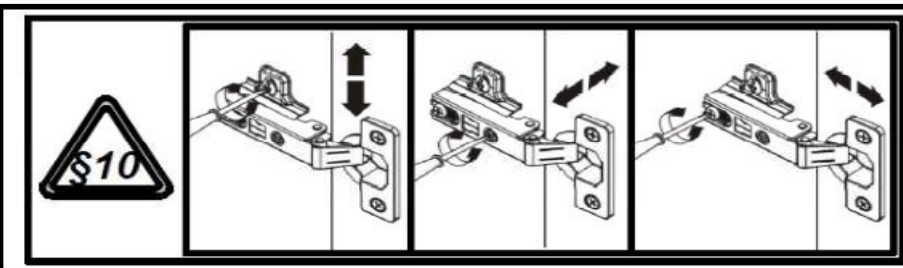
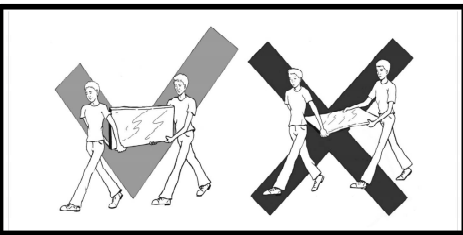
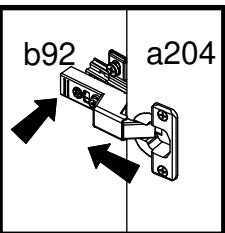

14

