

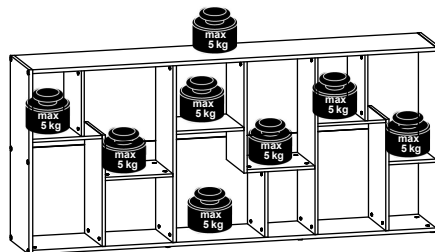

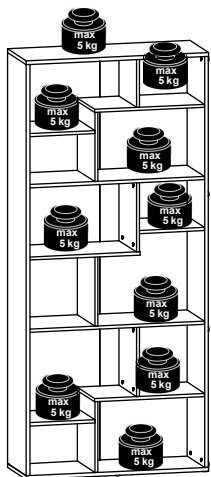

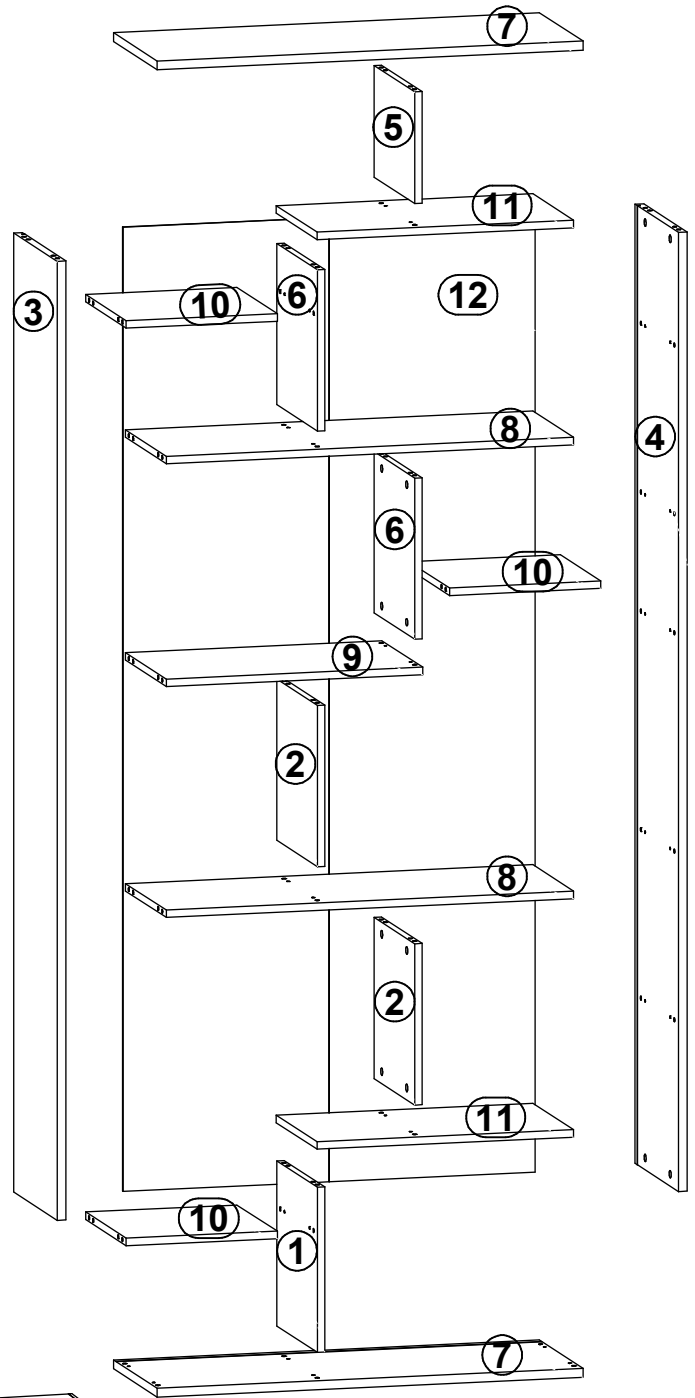

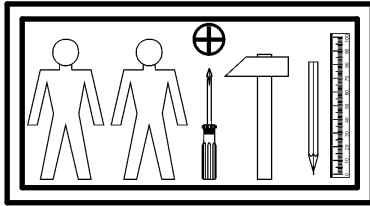



A

TETRIX

S442-REG/197/90

A	B	C	D
1	S442-1006	333	312 1/2
2	S442-1007	325	312 1/2
3	S442-1010	1933	334 1/2
4	S442-1011	1933	334 1/2
5	S442-1012	225	312 1/2
6	S442-1013	325	312 1/2
7	S442-2001	875	335 2/2
8	S442-3001	837	313 2/2
9	S442-3002	527	313 2/2
10	S442-3003	311	311 2/2
11	S442-3004	527	313 2/2
12	S442-9304	1943	847 1/2



- 
 58x
 Ø8x30 mm **f1**
- 
 8x
 Ø20x3mm **k103**
- 
 14x
l2
- 
 8x
 Ø2.9x16 mm **p55**
- 
 58x
 Ø15x12 mm #16 **r1**
- 
 58x
 20/11 **r42**
- 
 58x
 Ø 20mm **s68**
- 
 1x
n26/1
- 
 1x
 Ø3.5x16 mm **p38**

1 

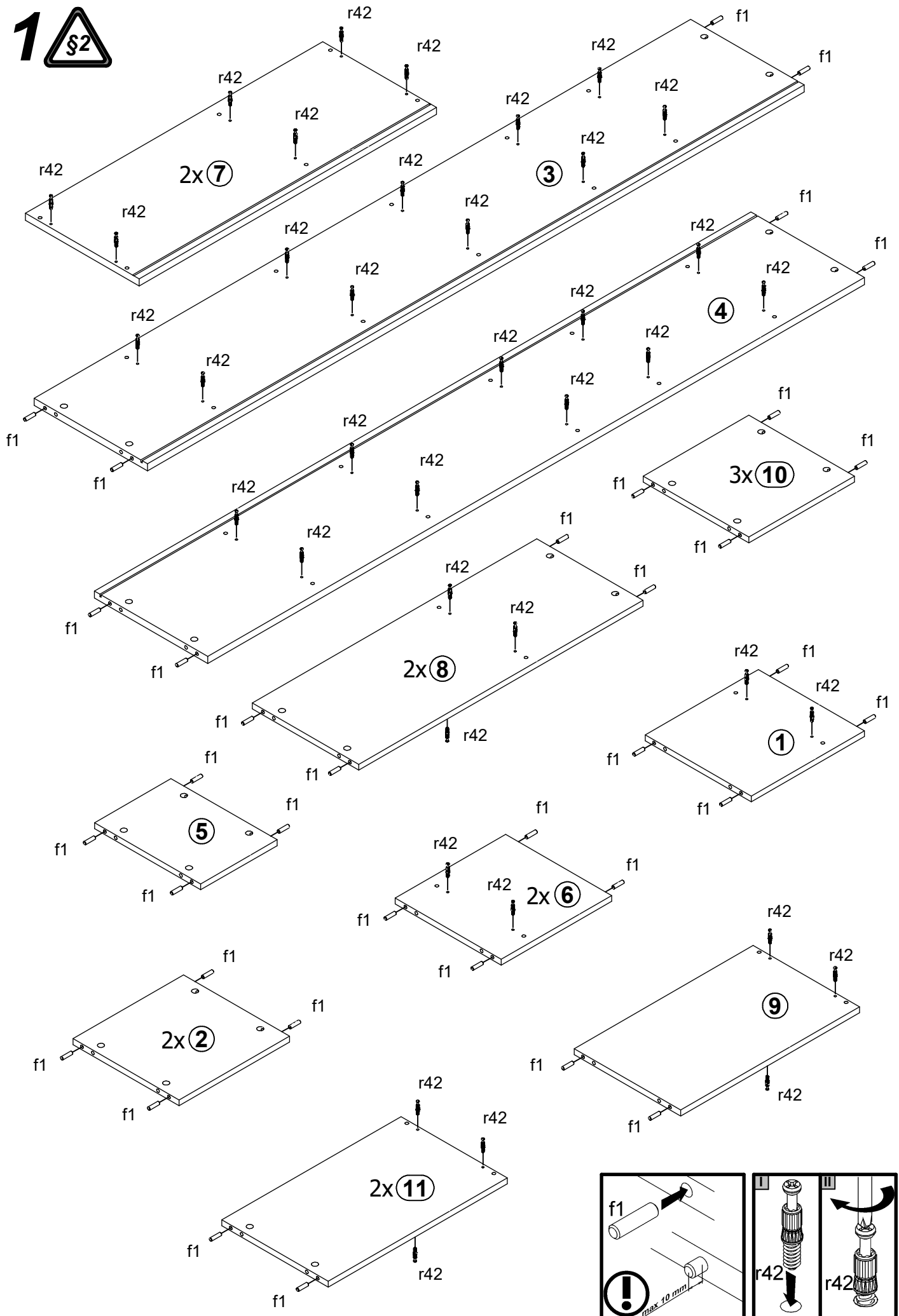

2

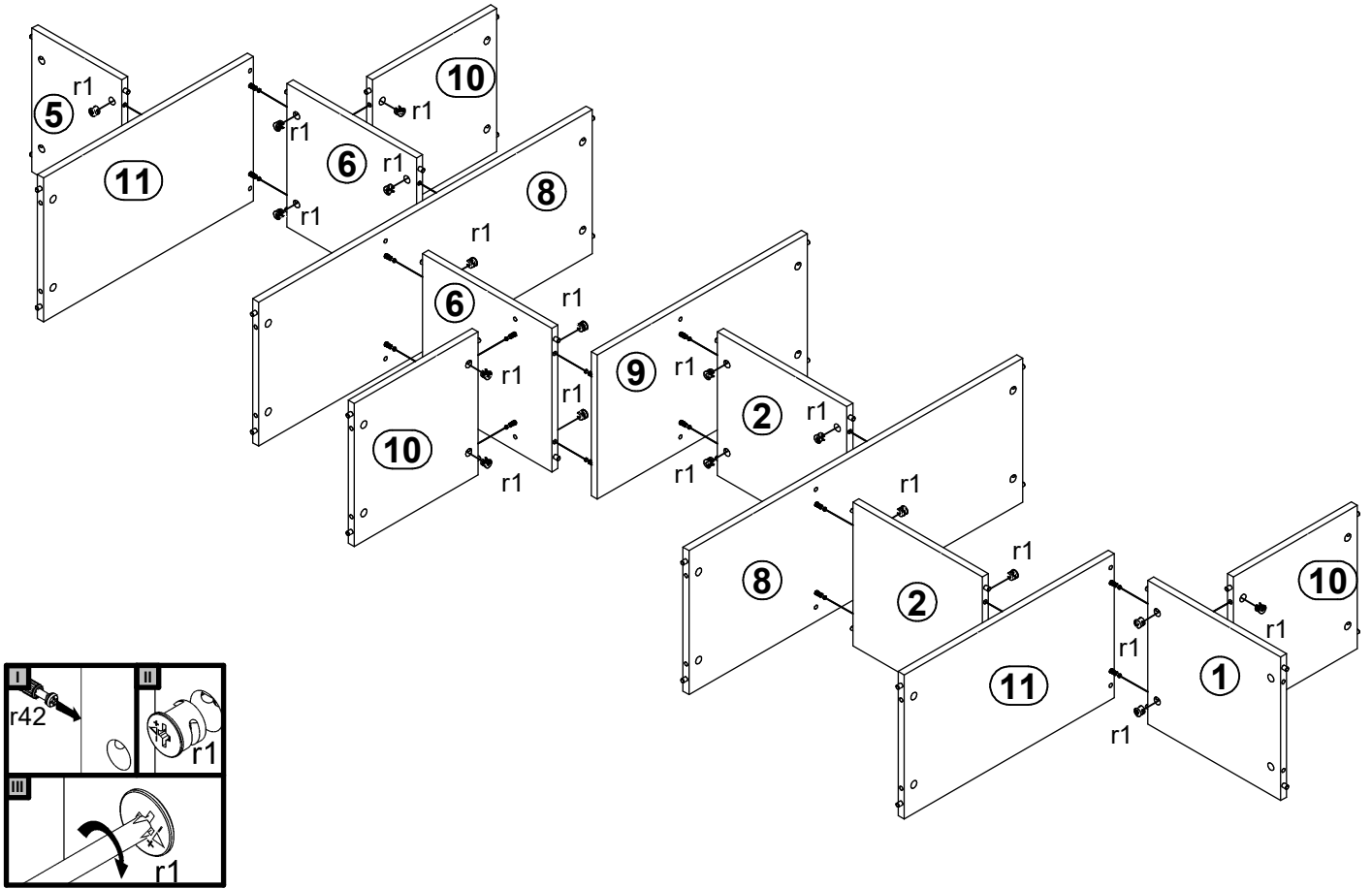

3

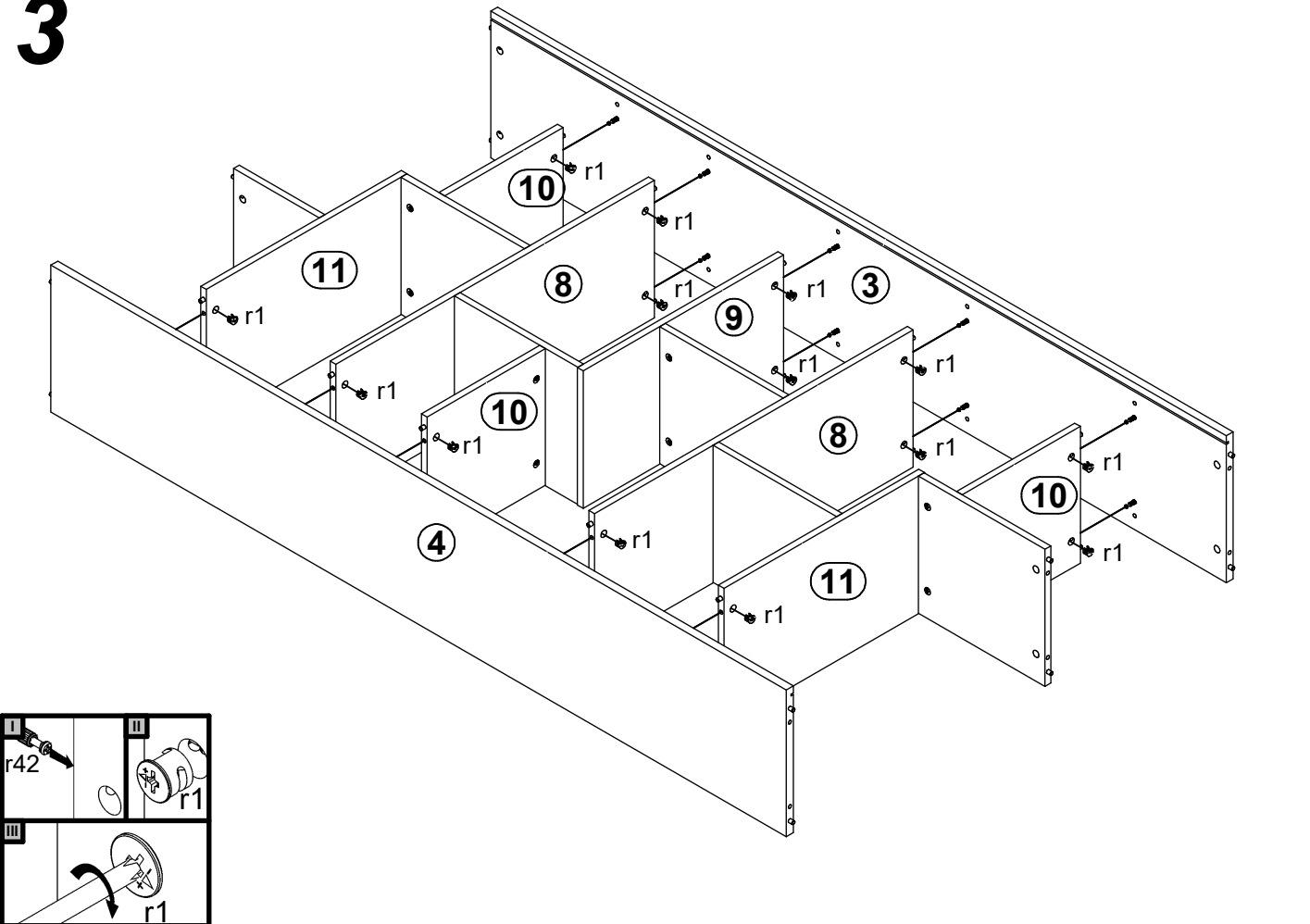

4

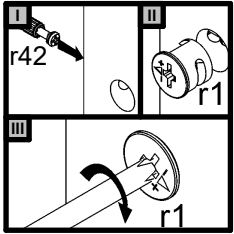
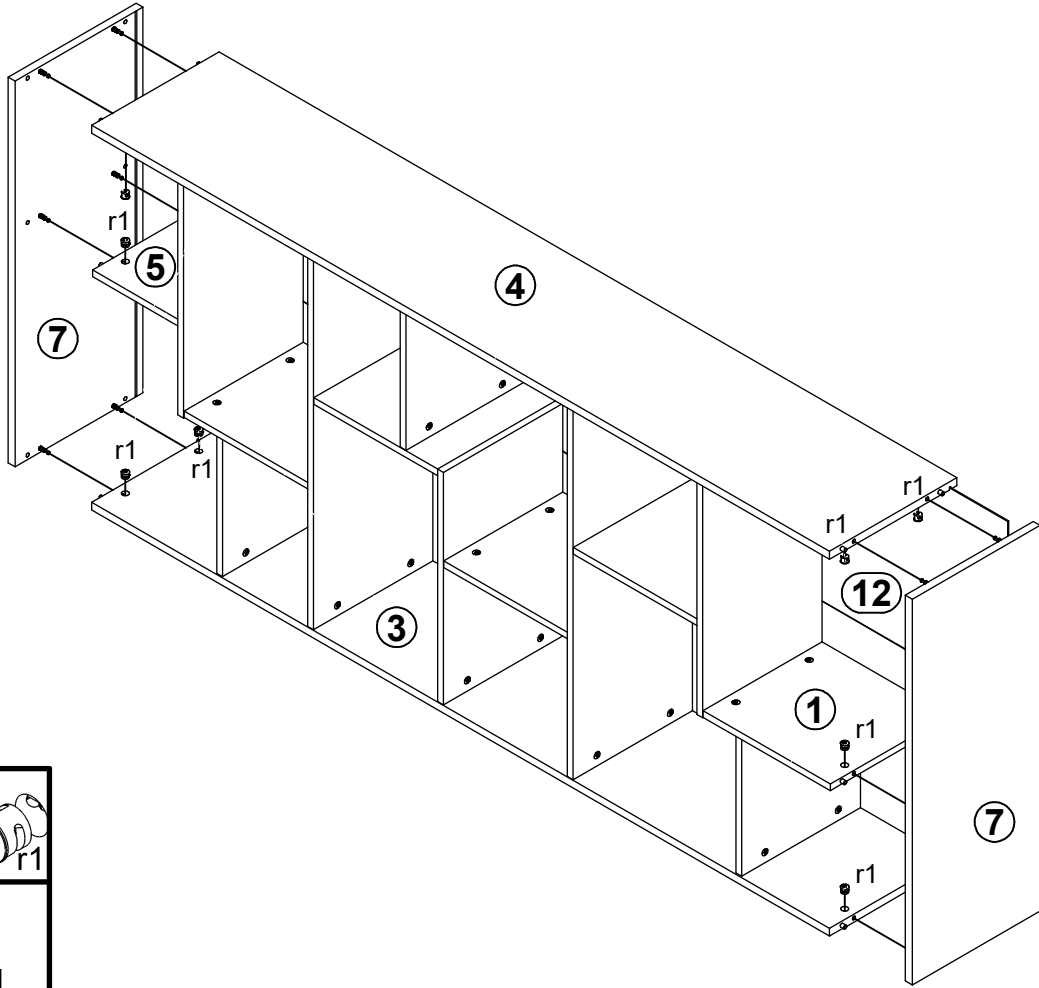

5

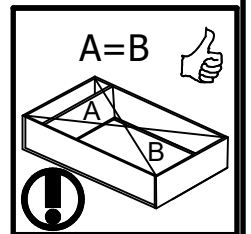
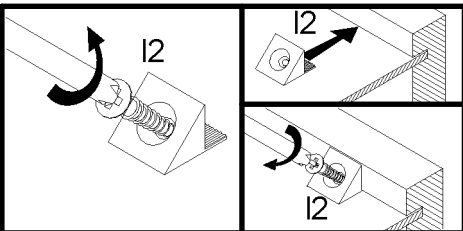
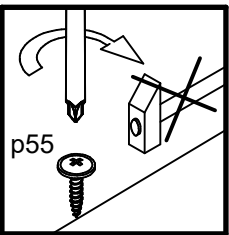
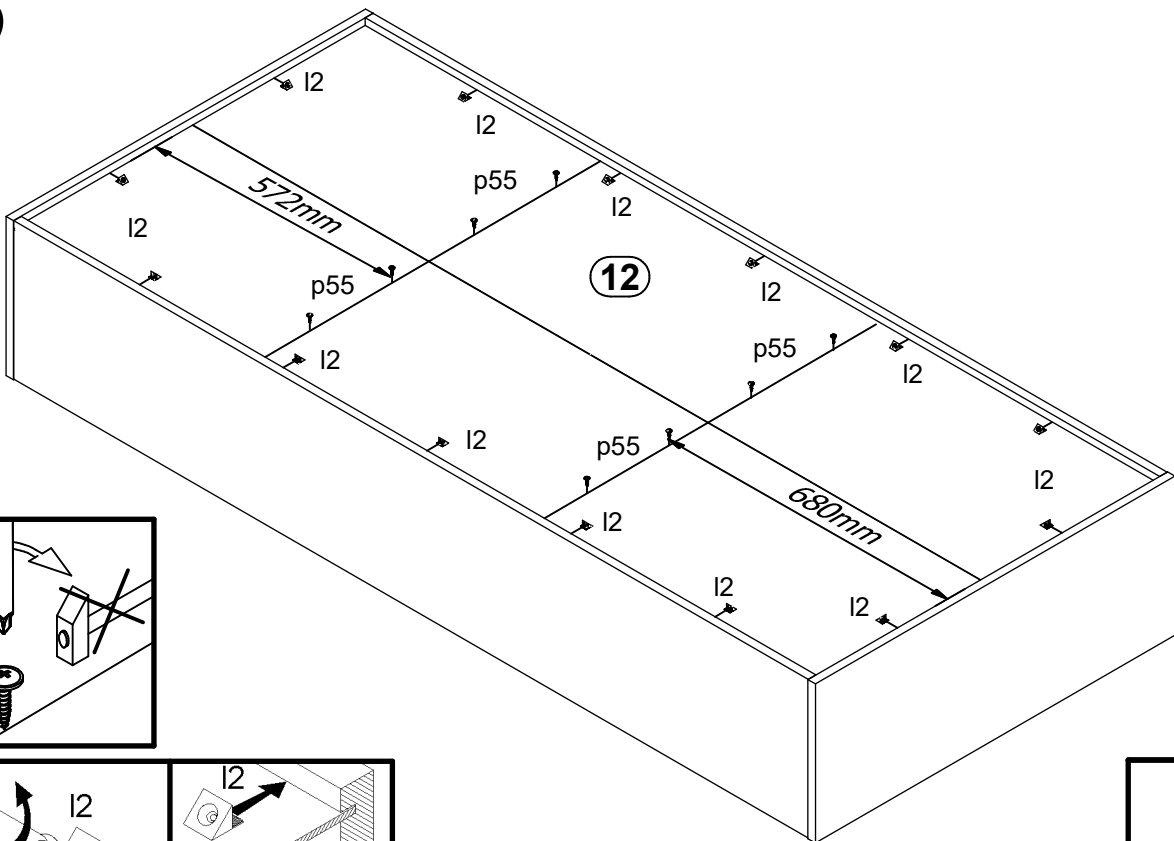

6A

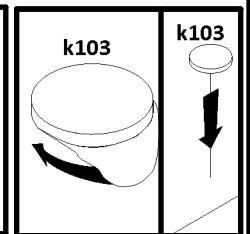
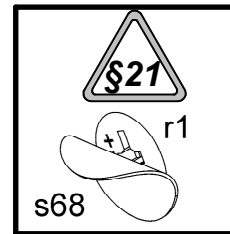
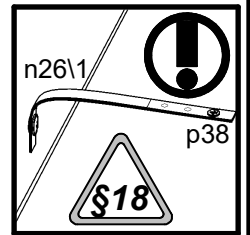
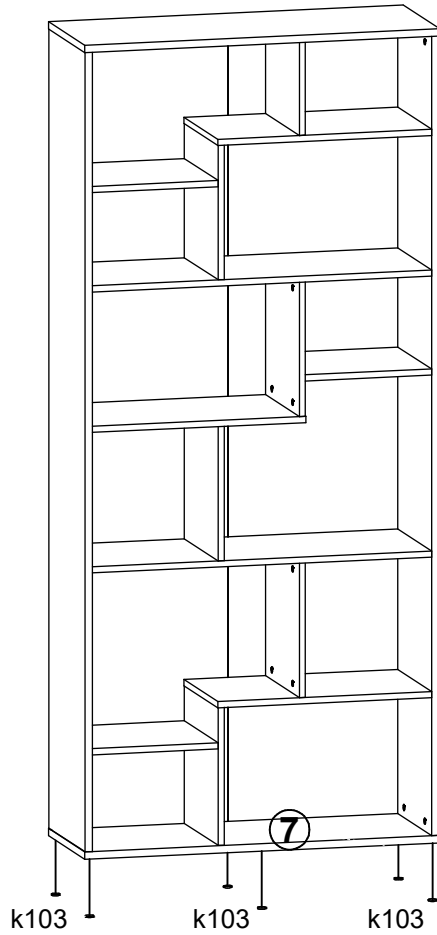

6B

