

Ø10mm

2h

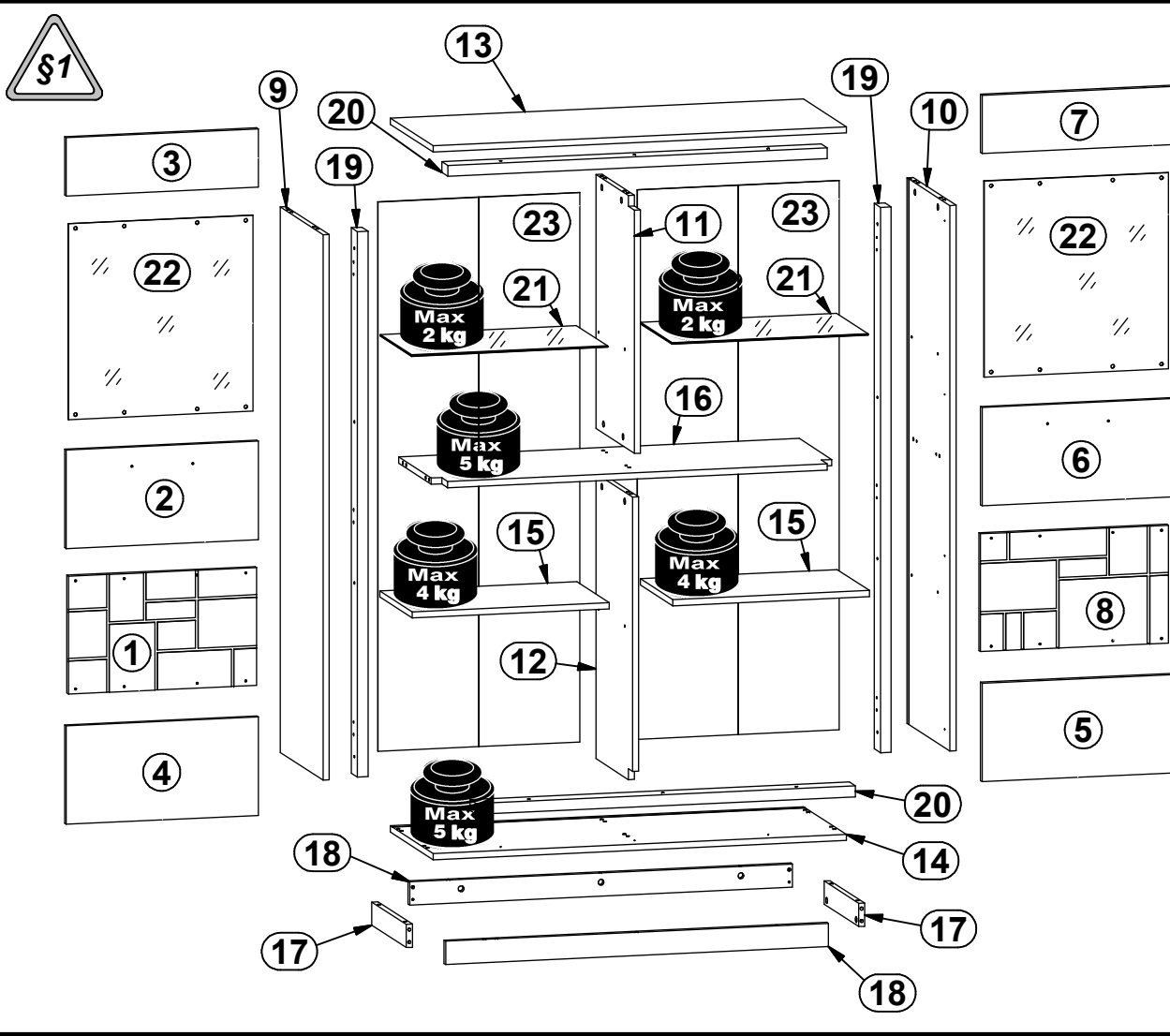

A	B	C (mm)			D
1	S605-0009	495	304	16	1/4
2	S605-0023	505	254	16	1/4
3	S605-0024	505	150	16	1/4
4	S605-0026	505	254	16	1/4
5	S605-0028	505	254	16	1/4
6	S605-0029	505	254	16	1/4
7	S605-0030	505	150	16	1/4
8	S605-0039	495	304	16	1/4
9	S605-1022	1408	420	16	3/4
10	S605-1023	1408	420	16	3/4
11	S605-1024	656	378	16	4/4
12	S605-1025	736	359	16	4/4
13	S605-2007	1087	420	16	3/4
14	S605-2008	1087	420	16	3/4
15	S605-3008	518	318	16	4/4
16	S605-3010	1054	378	16	4/4
17	S605-4004	338	60	16	1/4
18	S605-4014	1007	60	16	4/4
19	S605-4015	1408	60	28	3/4
20	S605-4016	998	60	28	4/4
21	S605-5002	517	309	4	4/4
22	S605-5502	485	506	4	2/4
23	S605-9308	1418	531	2,5	3/4

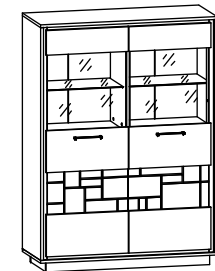

D
4/4

4x a205	2x a212	6x b92	2x c559/3	8x d1	8x d3	6x e1	16x e47	32x f1	4x j30	6x k1	10x l2	1x n26
7x n108	16x o54	1x p38	12x p51	13x p55	14x p64	16x p94	24x r1	24x r42	12x s59	10x s68	1x z1	

1

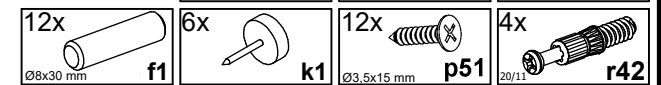
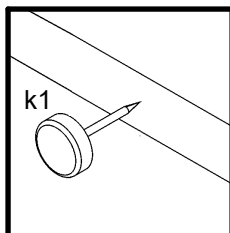
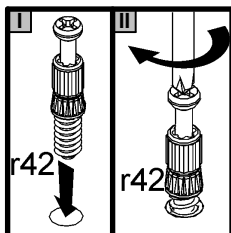
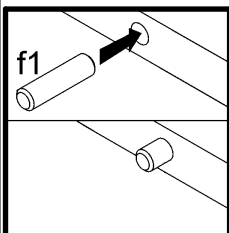
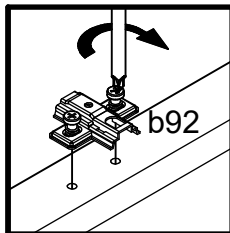
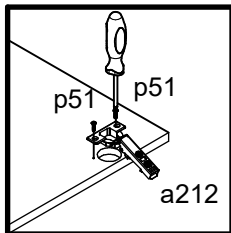
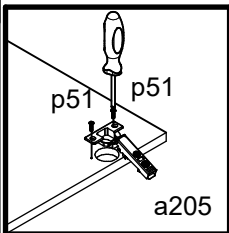
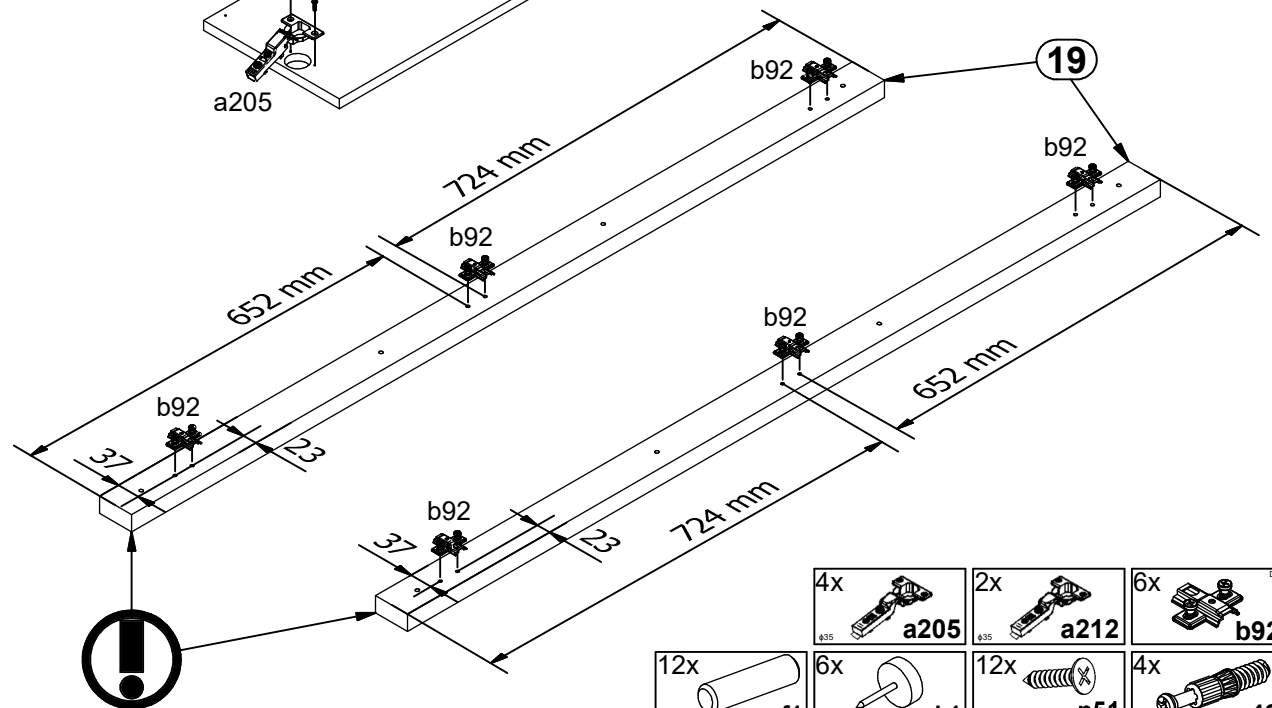
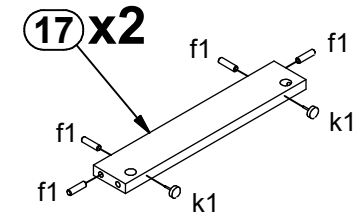
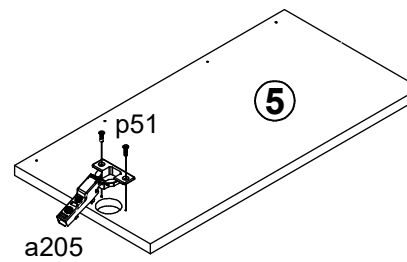
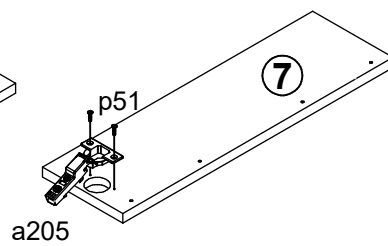
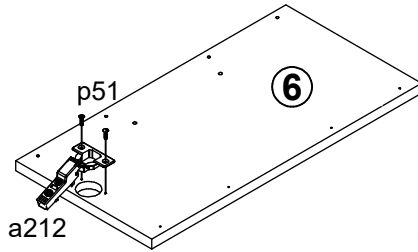
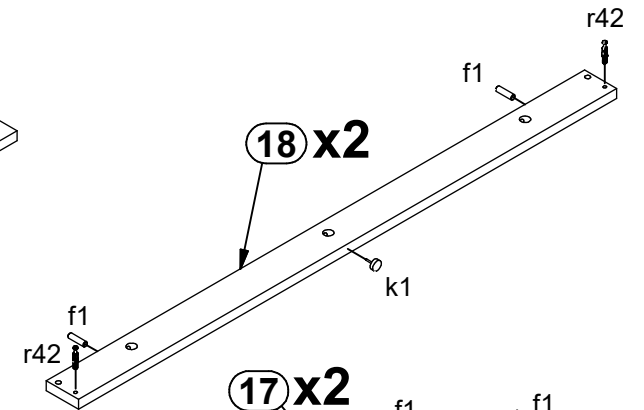
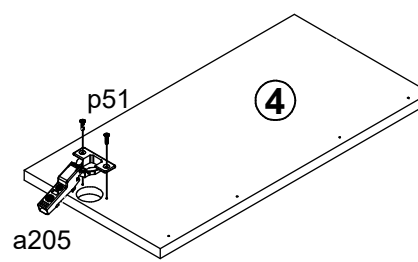
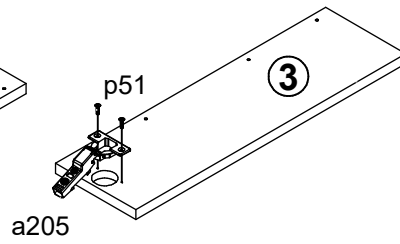
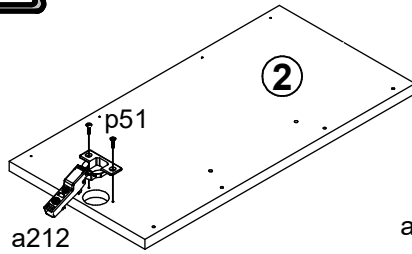

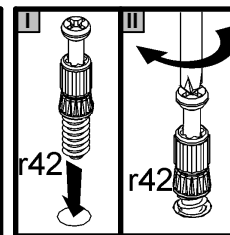
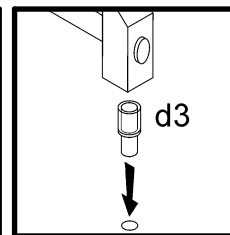
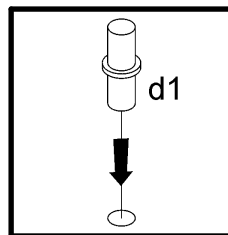
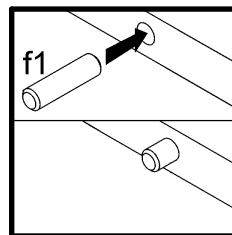
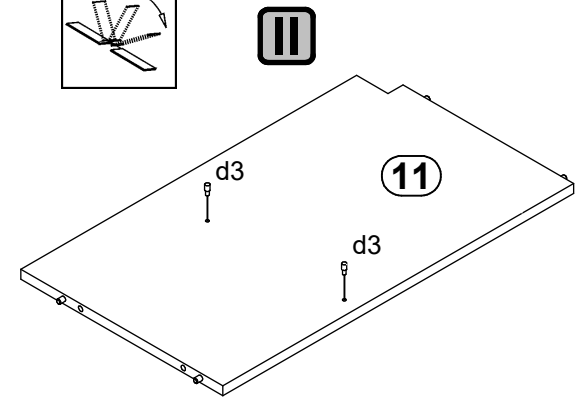
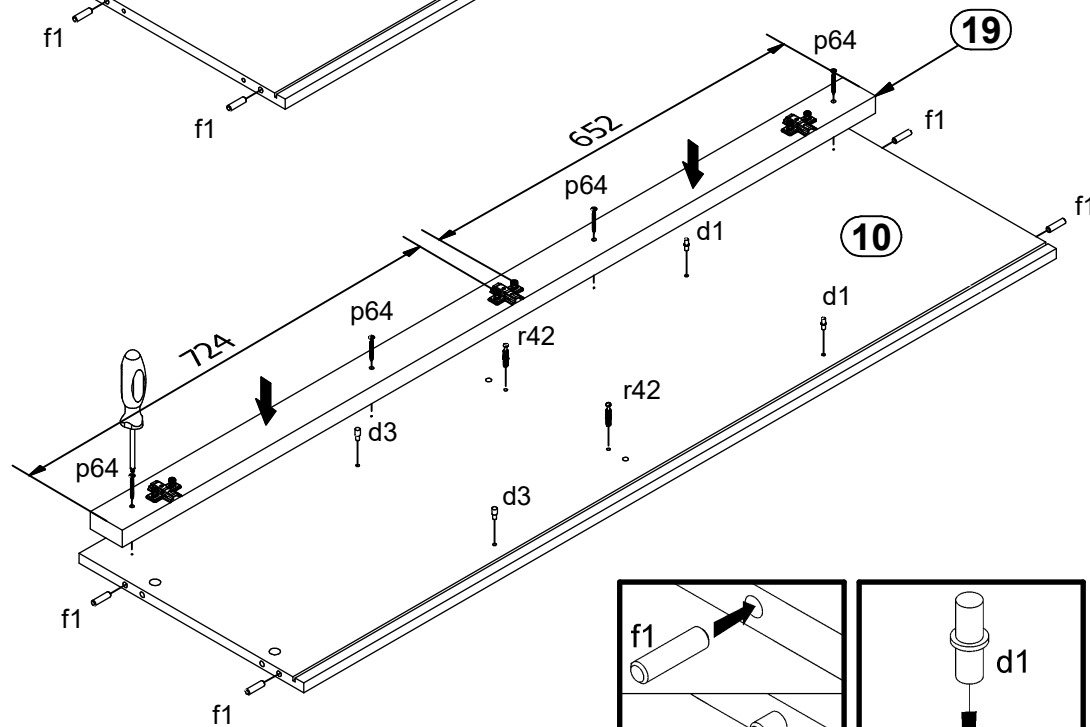
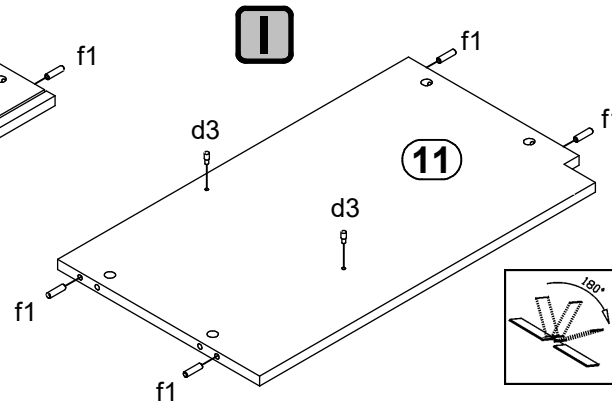
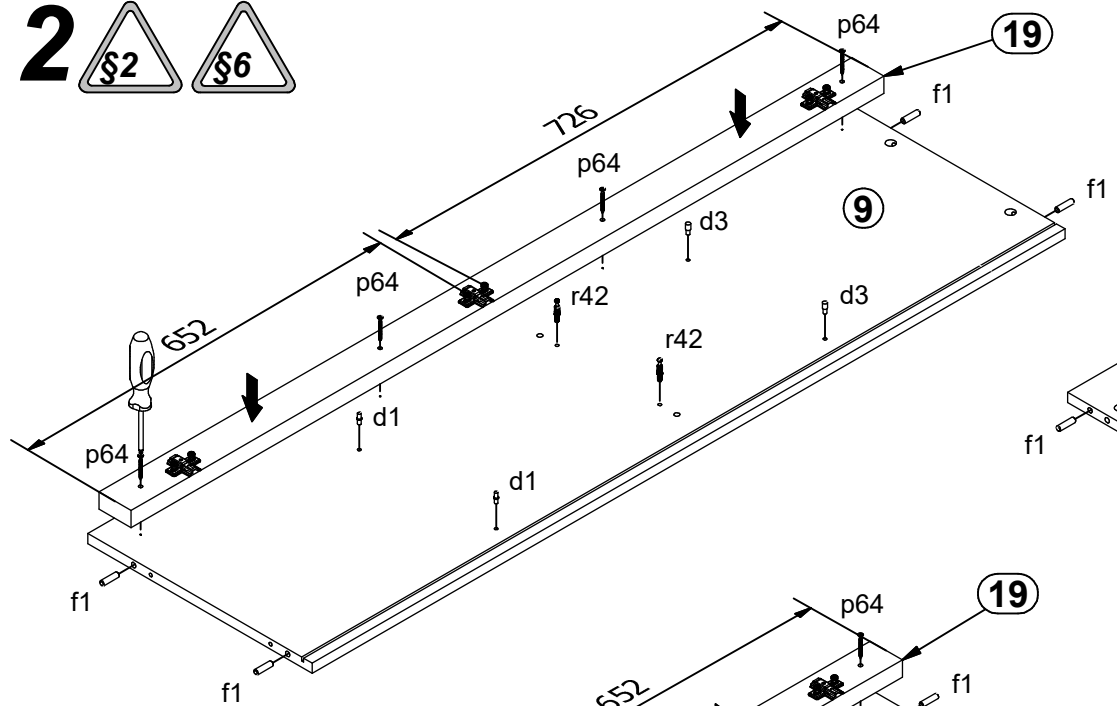

12x Ø8x30 mm f1	4x Ø5x17 mm d1	8x Ø5x17 mm d3	8x Ø4x40 mm p64	4x 20/1.1 r42
-----------------------	----------------------	----------------------	-----------------------	---------------------

3  

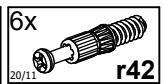
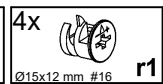
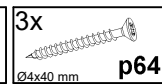
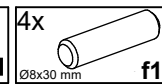
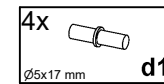
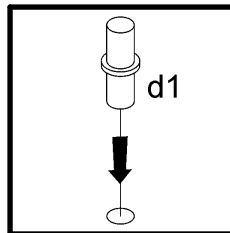
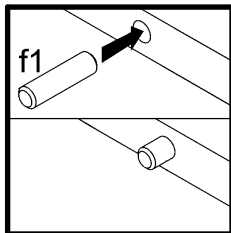
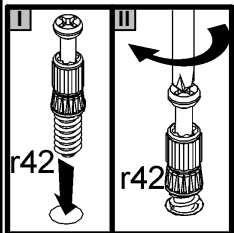
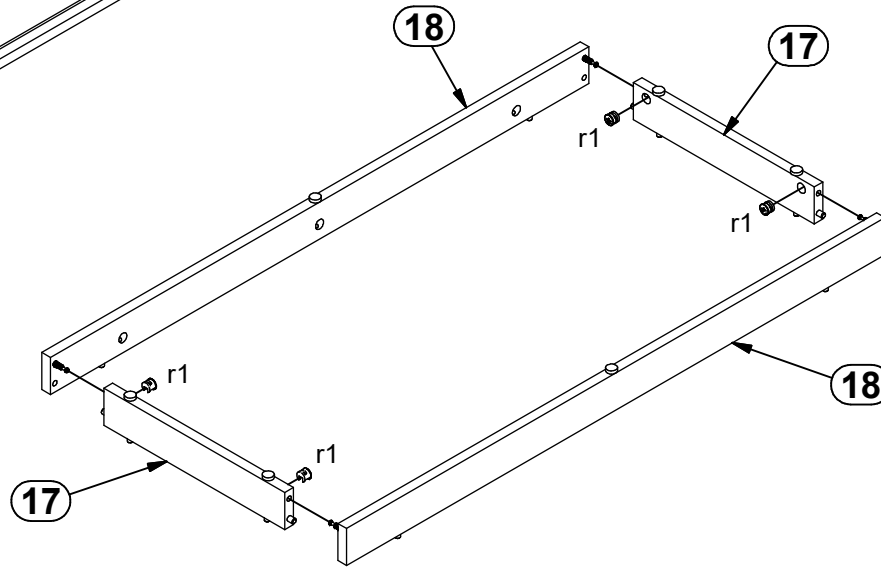
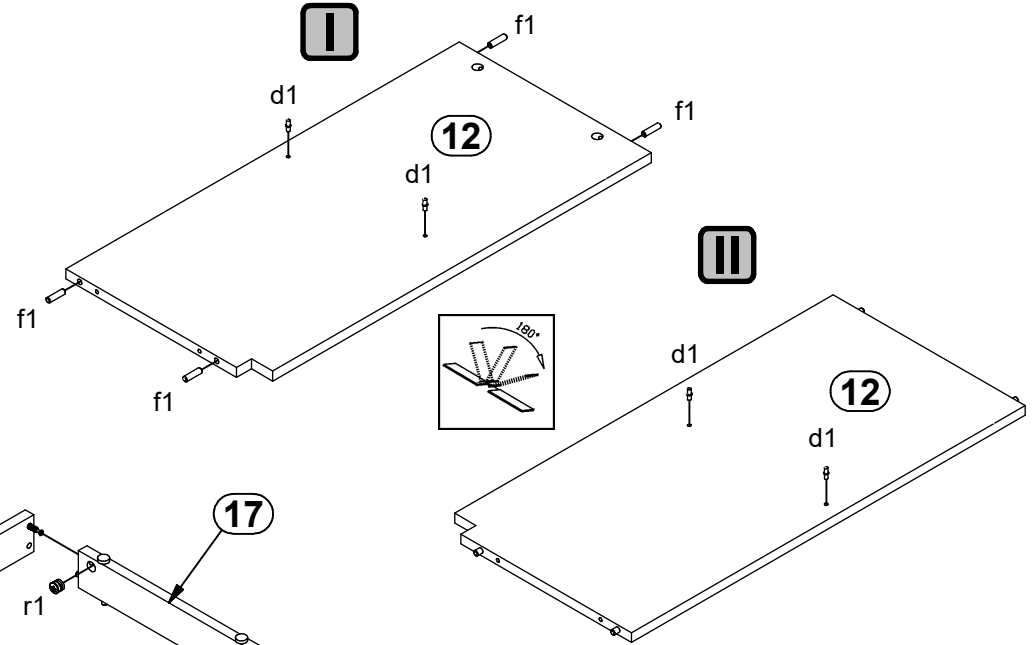
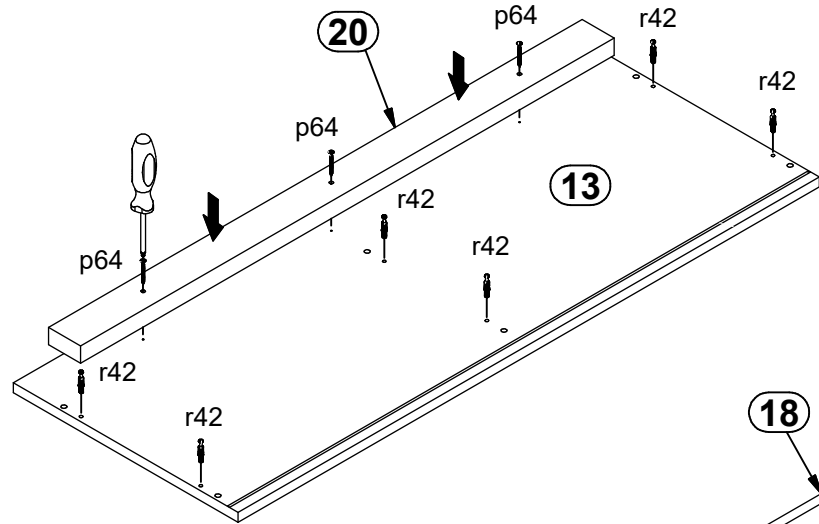

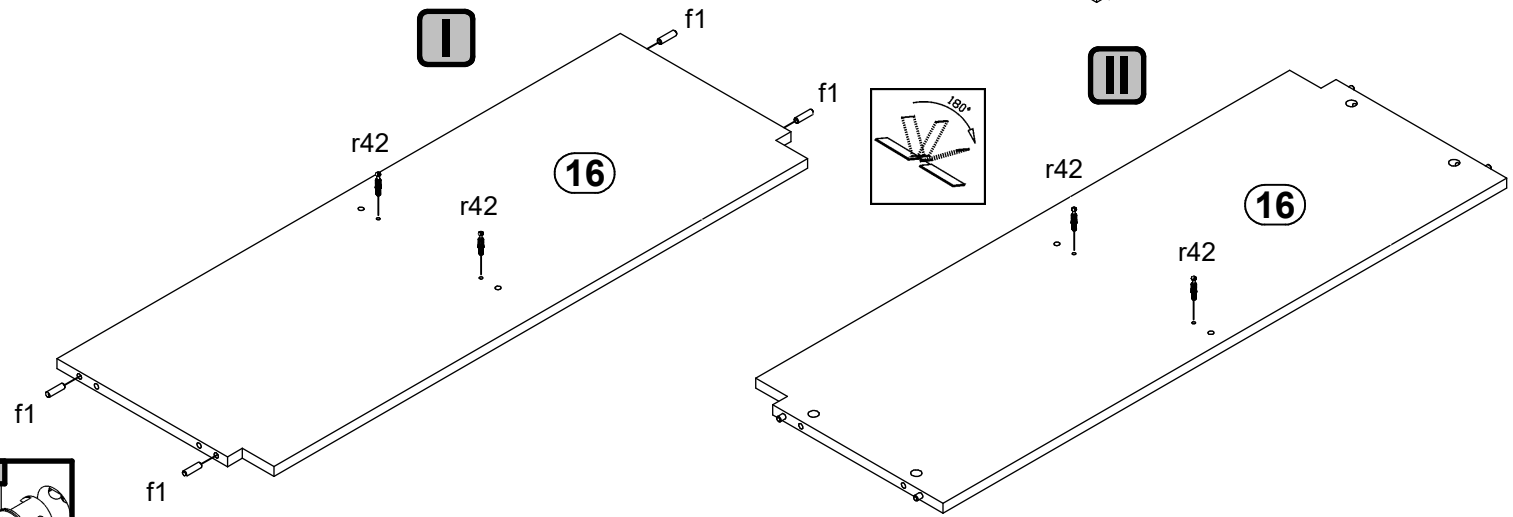
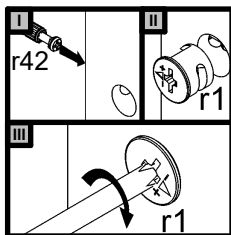
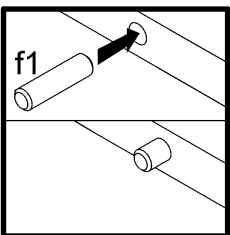
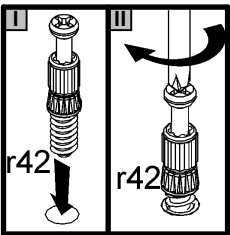
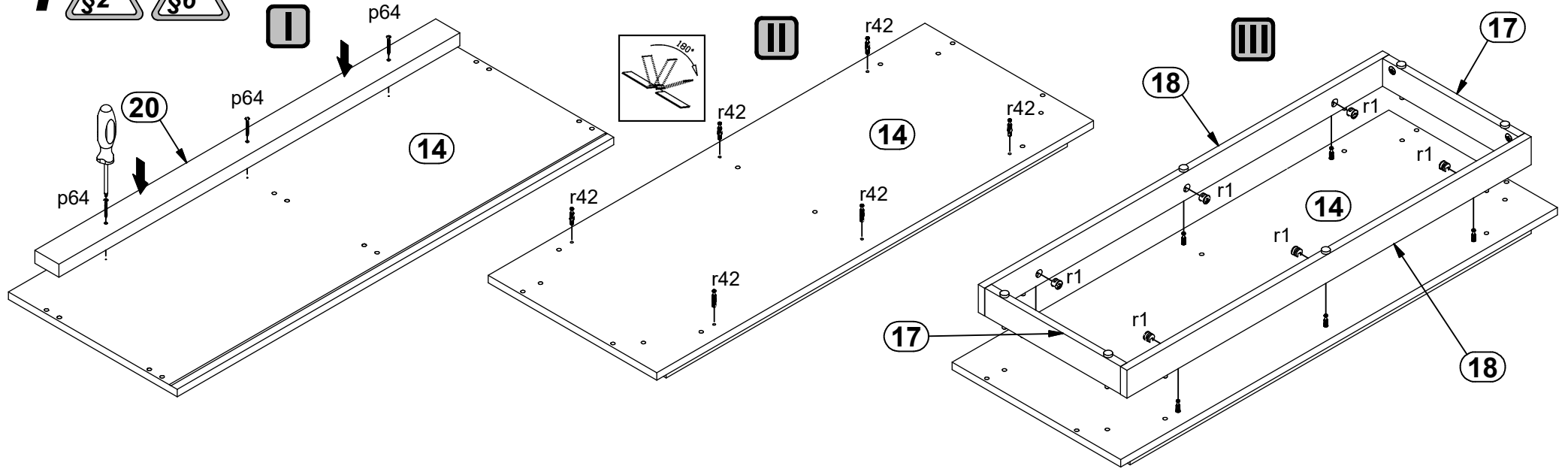

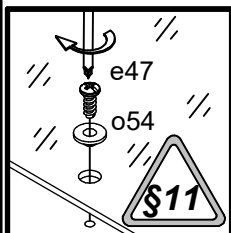
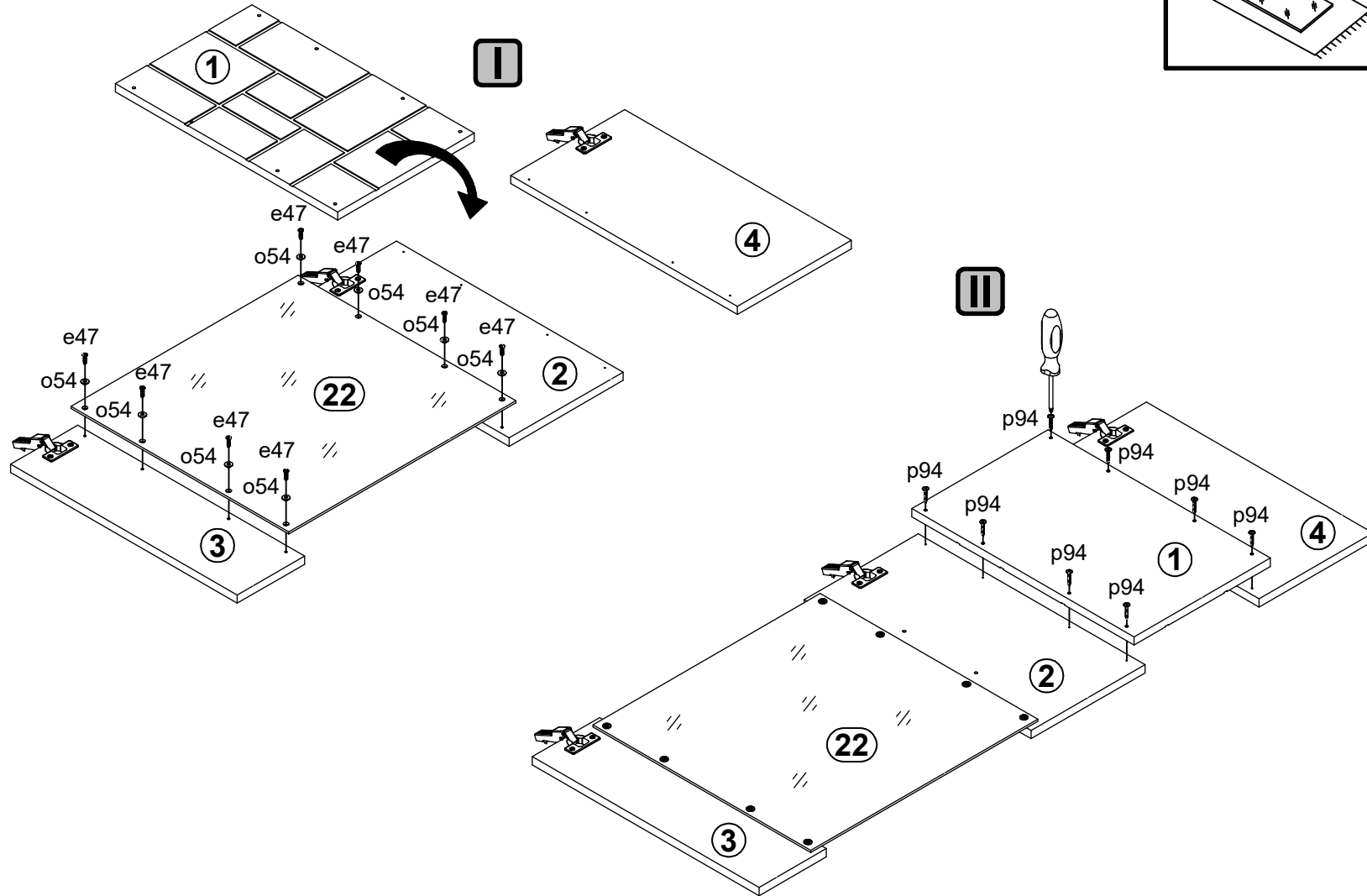
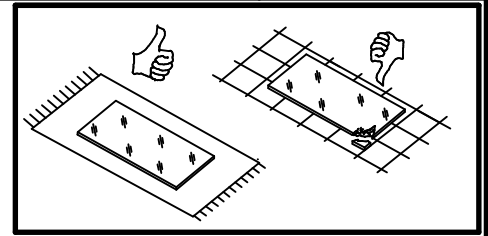

4x Ø8x30 mm f1	3x Ø4x40 mm p64	6x Ø15x12 mm #16 r1	10x 20/11 r42
----------------------	-----------------------	---------------------------	---------------------

5 

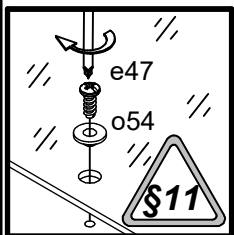
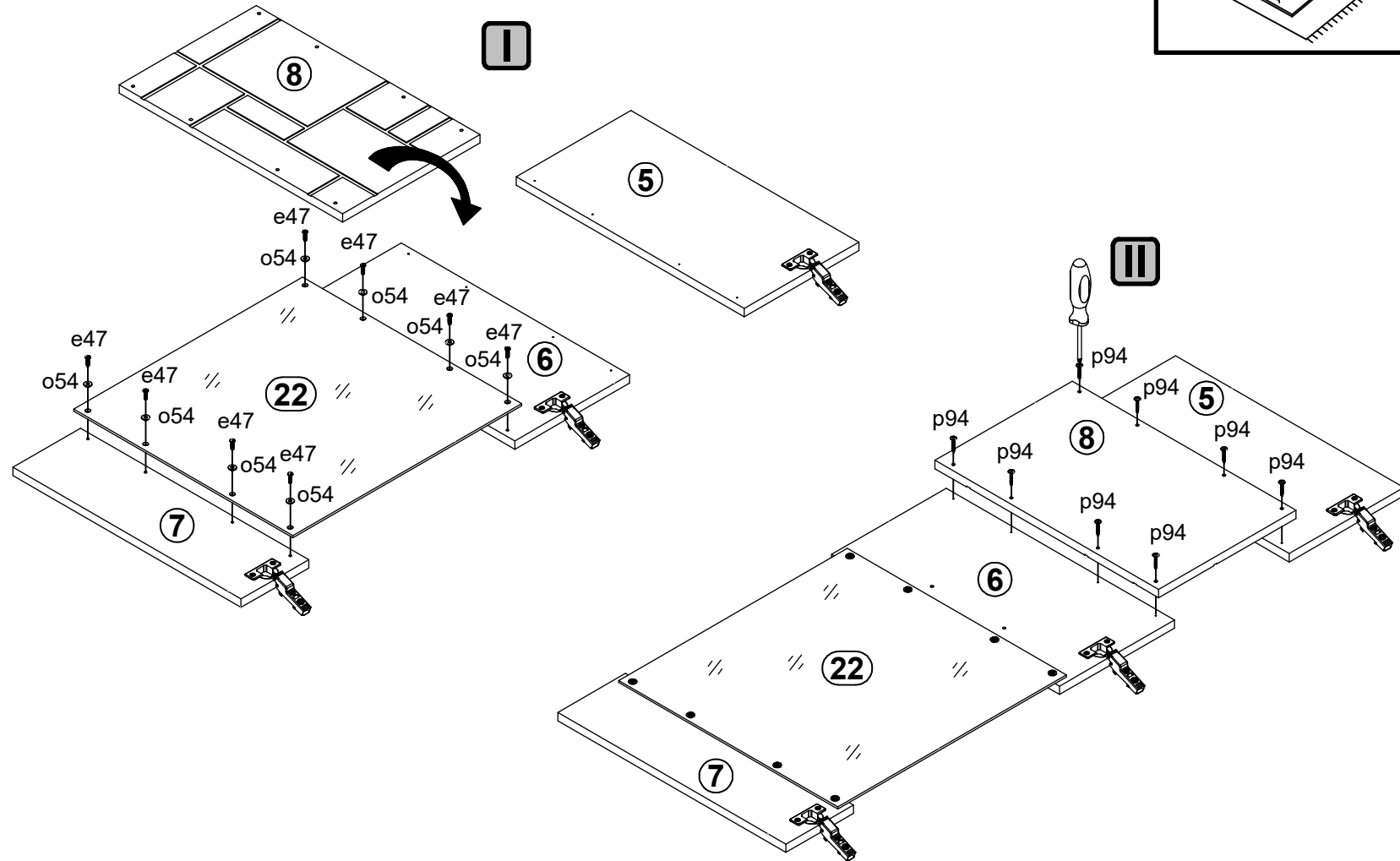
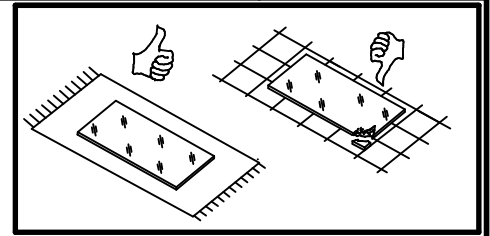

6



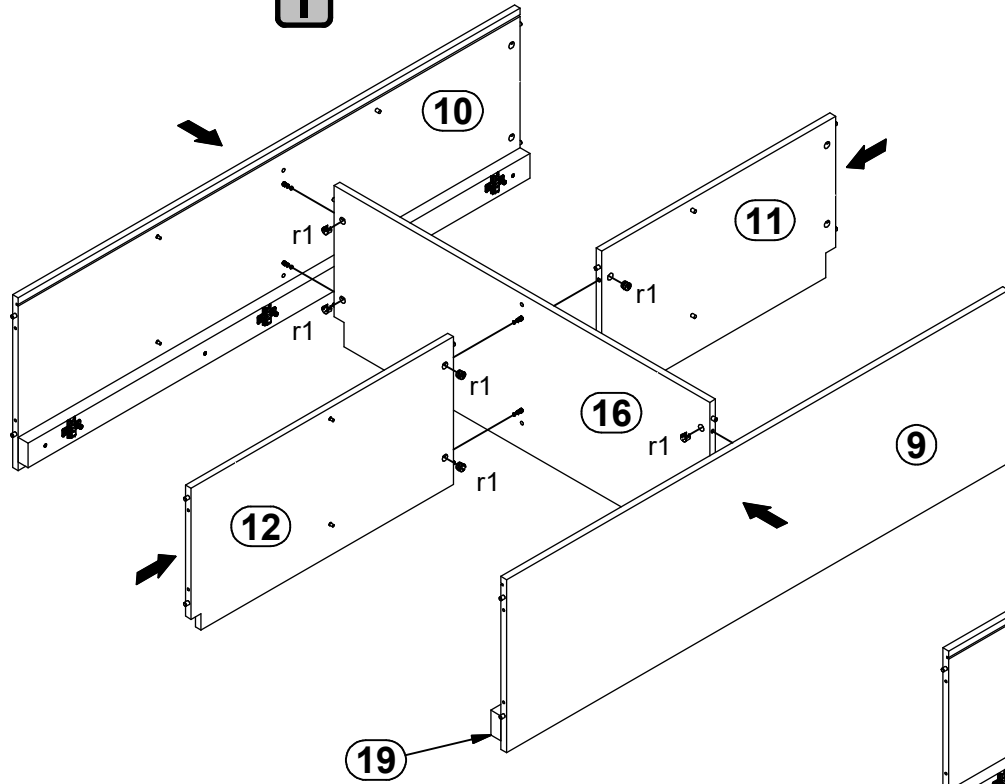

7 

I

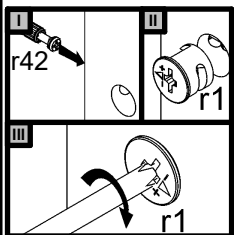
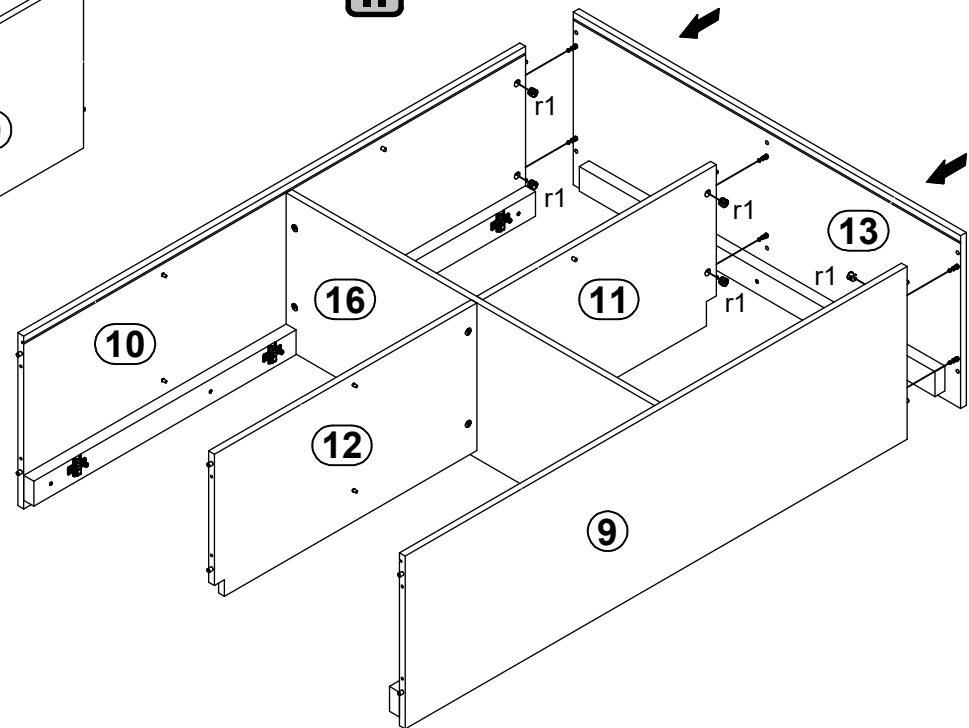

II



14x  r1
Ø15x12 mm #16

8 

I

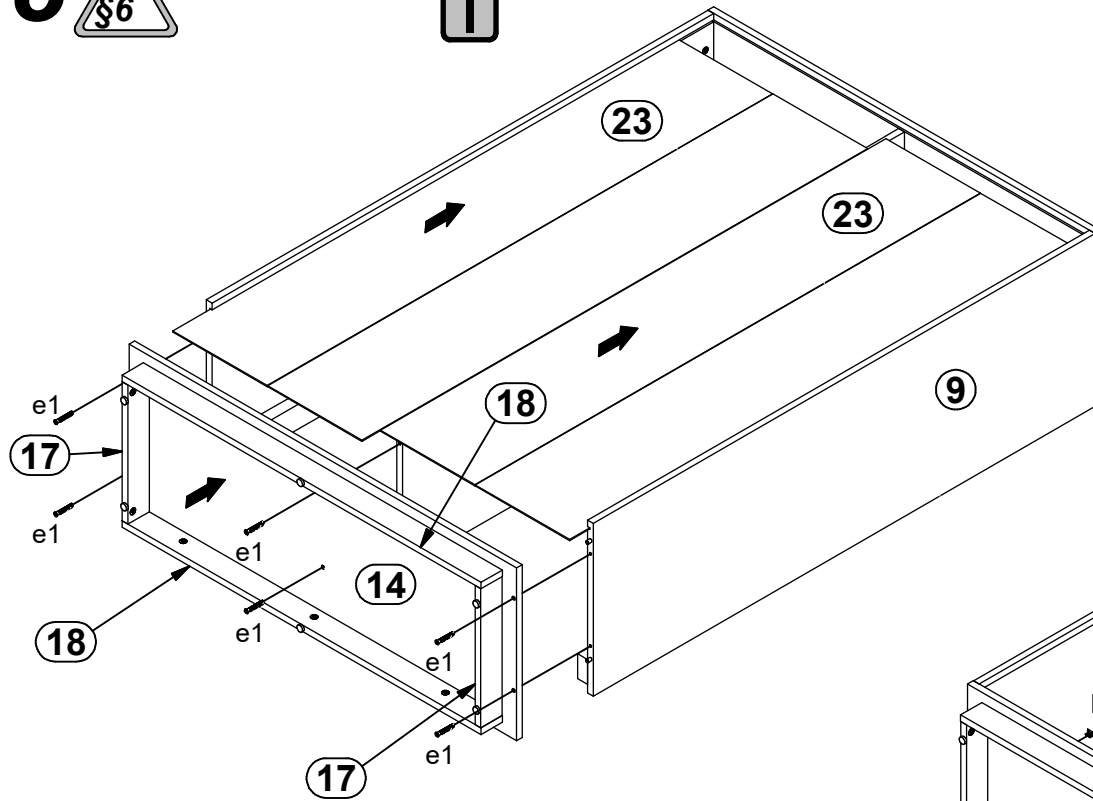

II

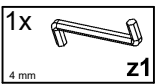
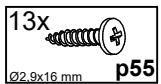
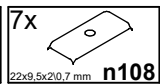
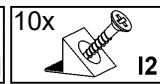
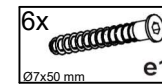
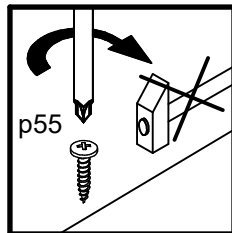
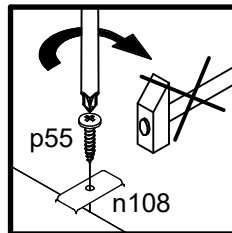
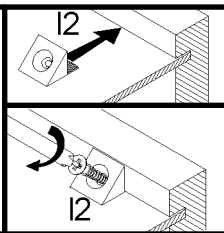
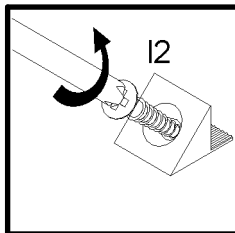
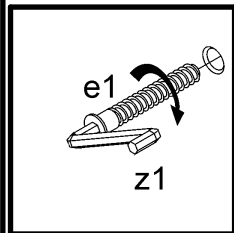
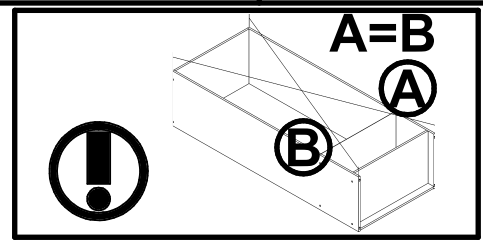
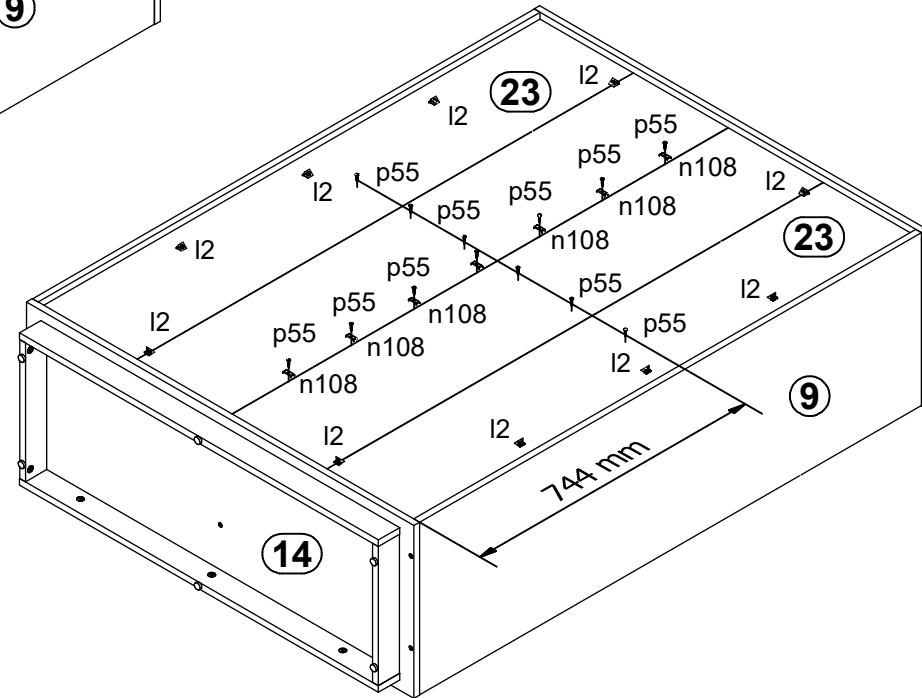

9 §6

I

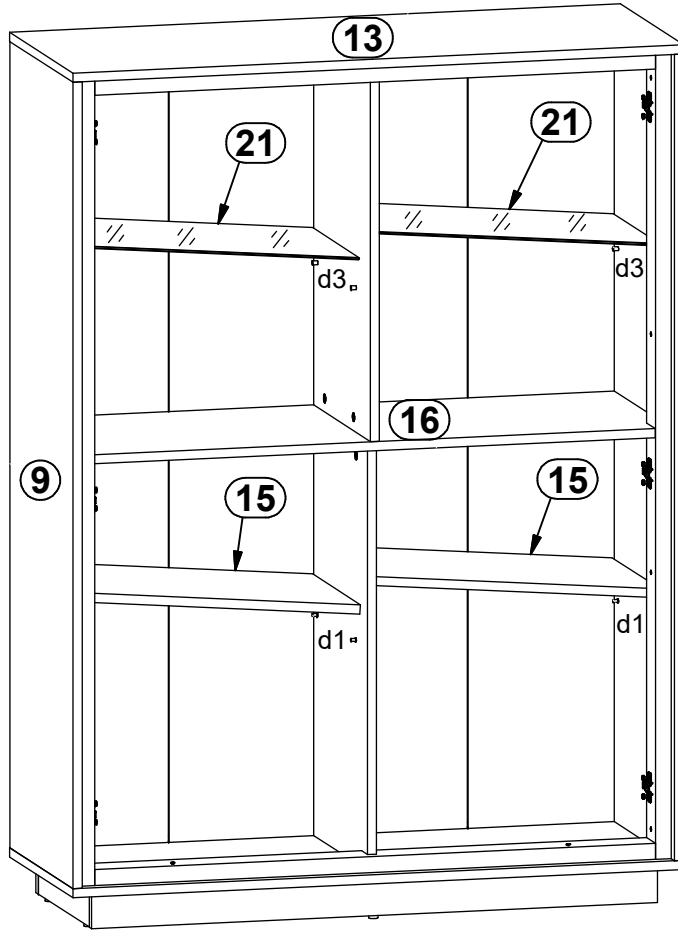
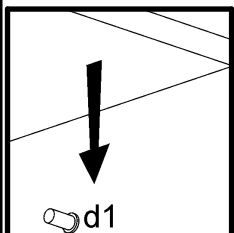
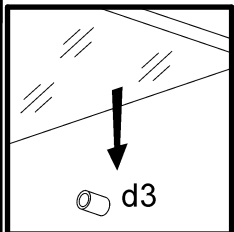
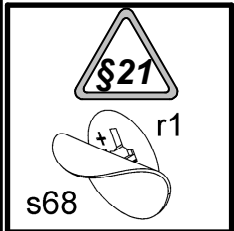
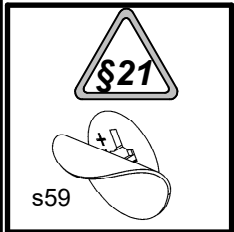
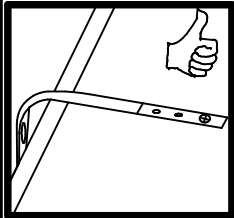

II

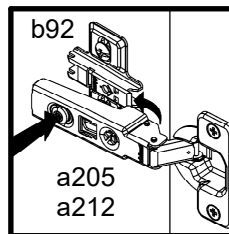
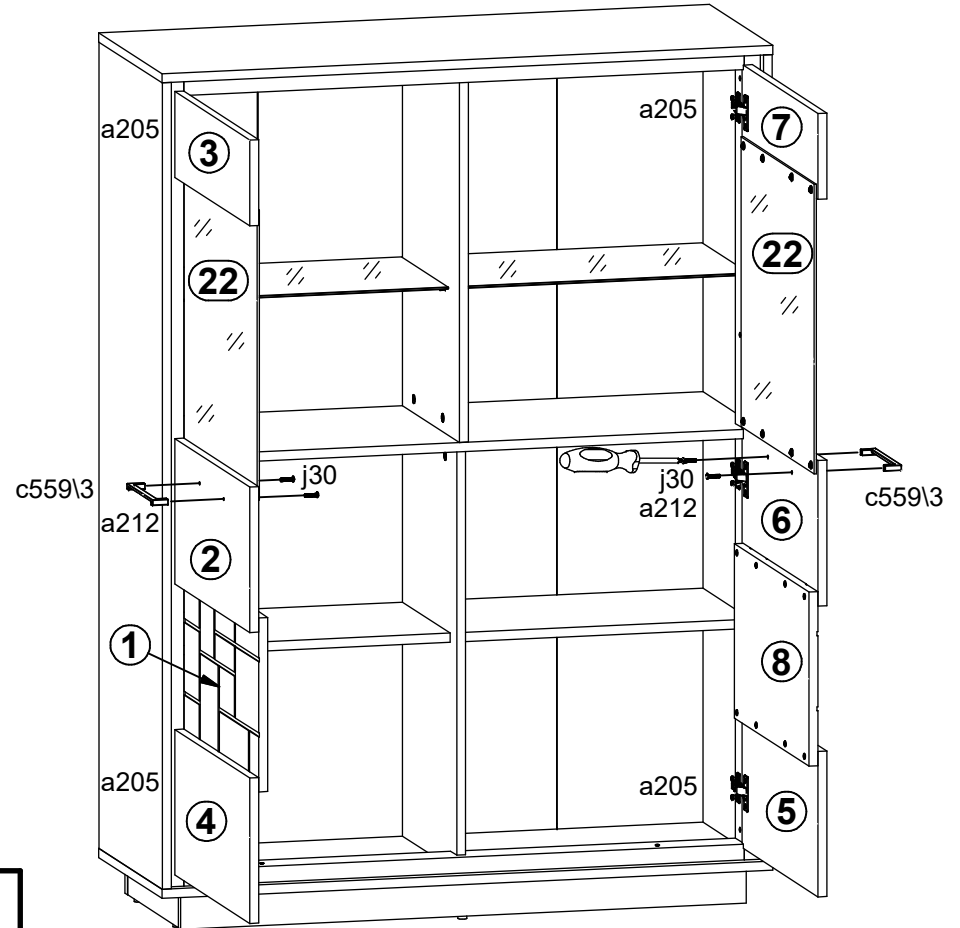
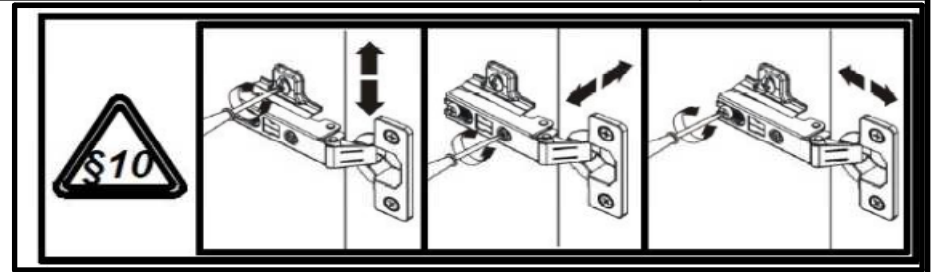

2x c559\3	4x M4x22 mm j30	1x n26
1x Ø3.5x16 mm p38	12x Ø14x0.5 mm s59	10x Ø 20mm s68

10

