

A

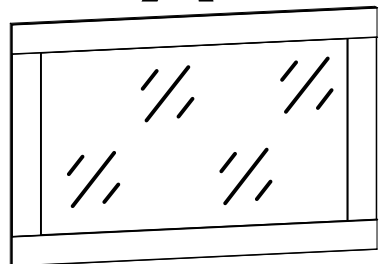

B

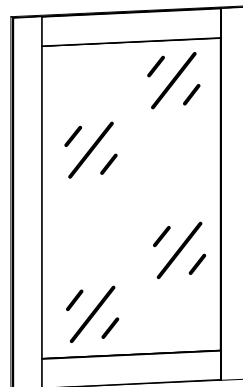

A	B	C1	C2	C3	D
1	M253-4301	650	1000	21	1/1

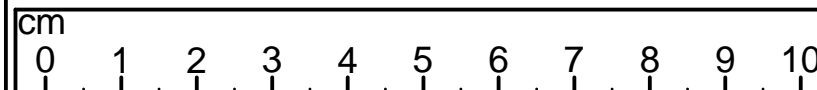
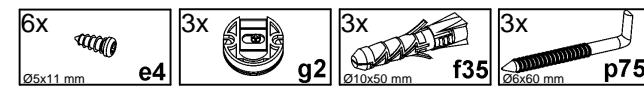
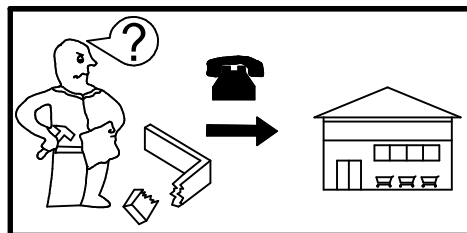
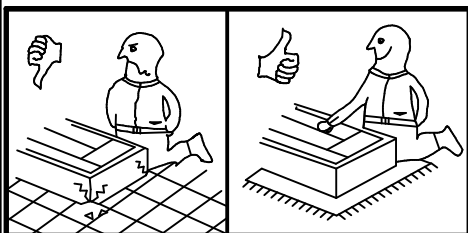
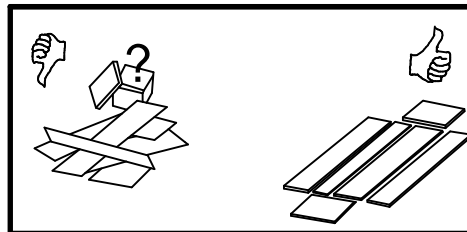
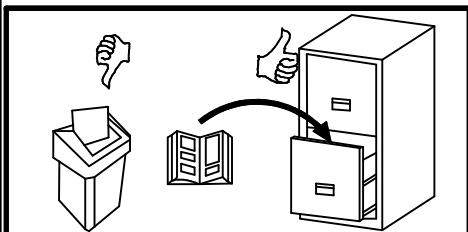
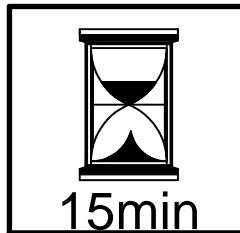
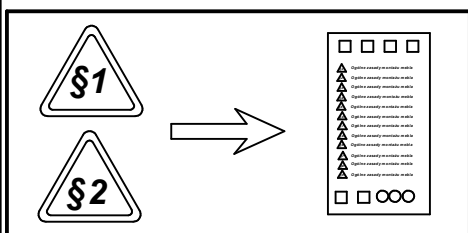
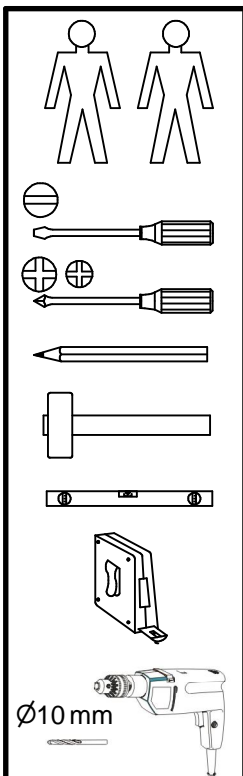
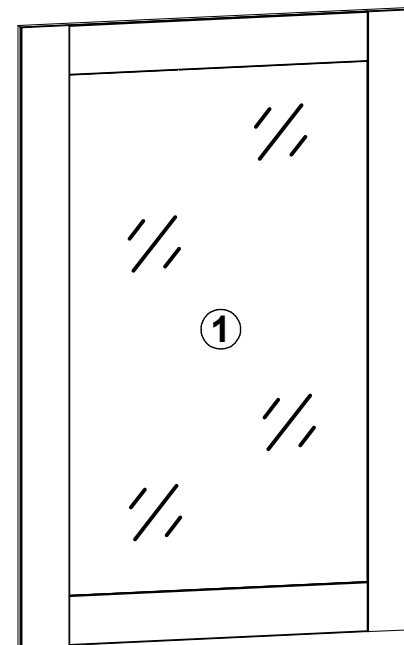

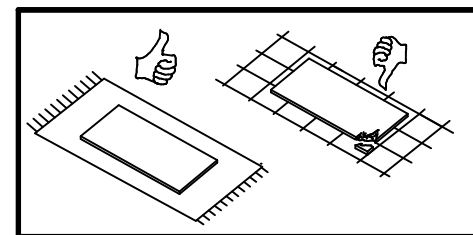
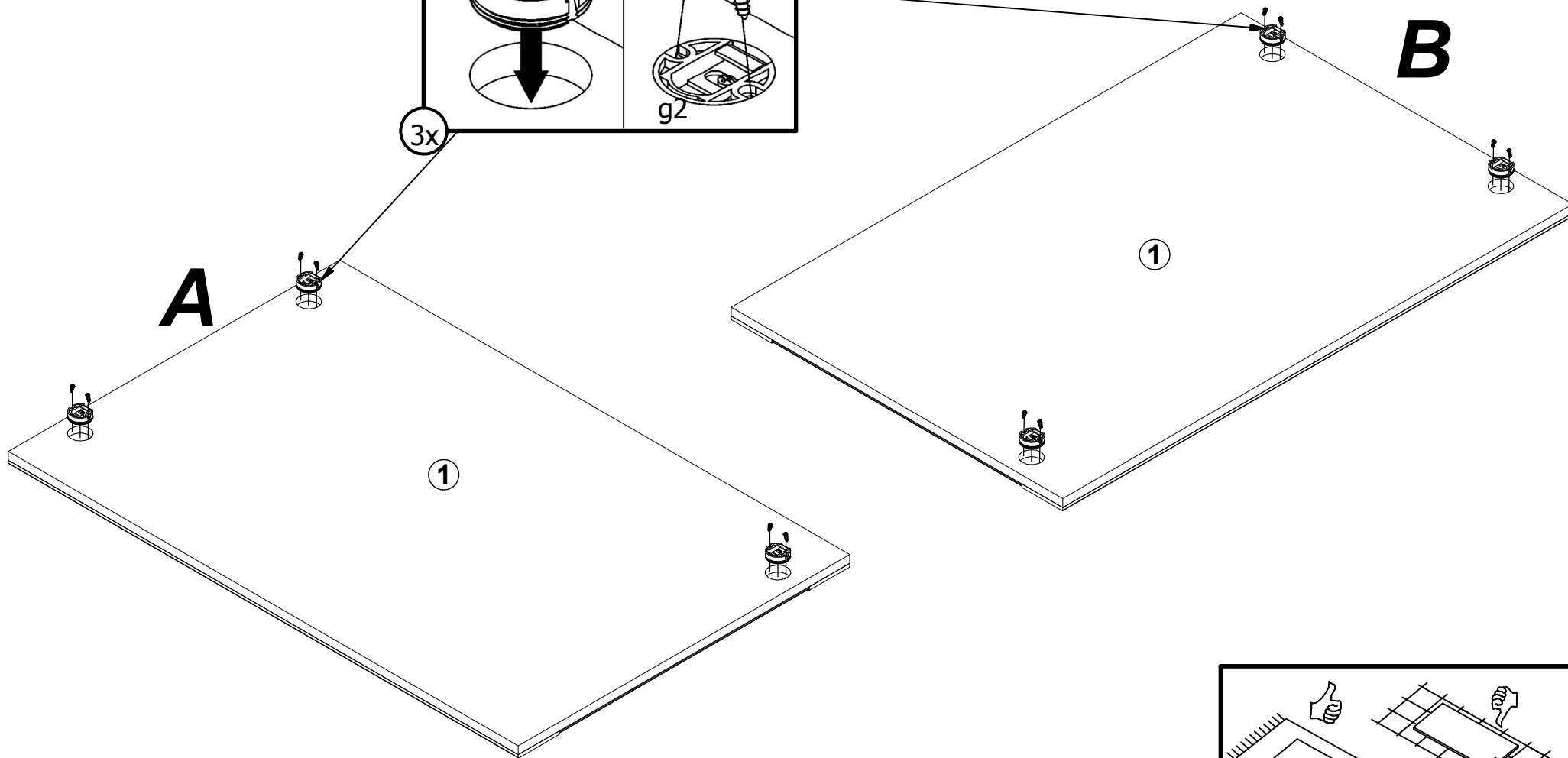
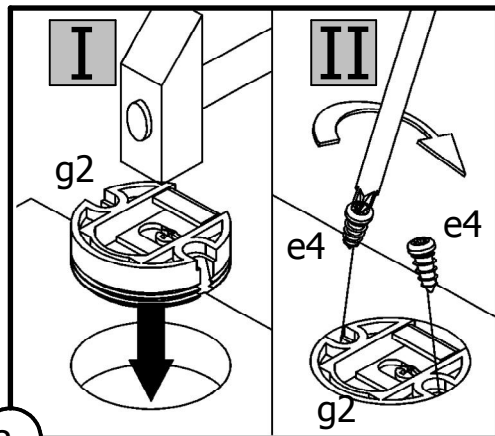

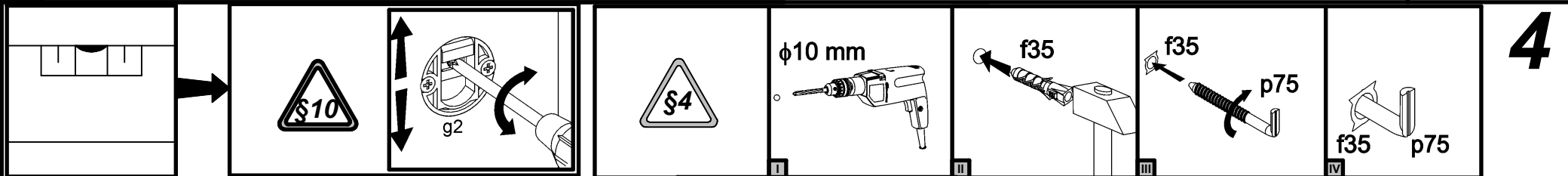

4

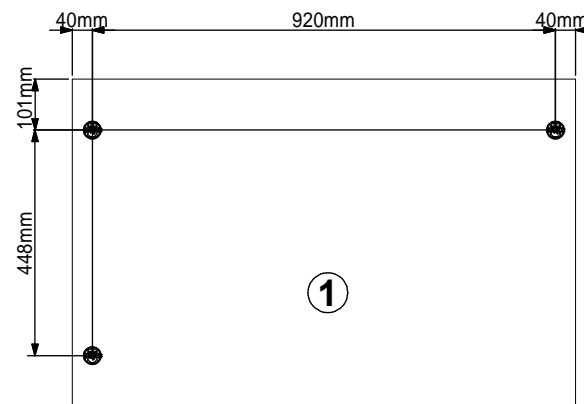
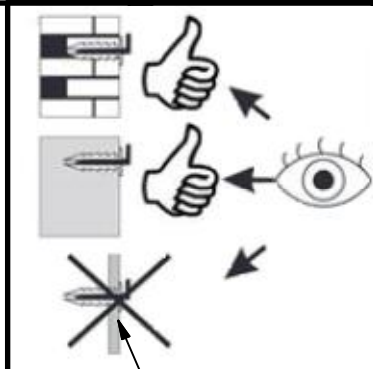
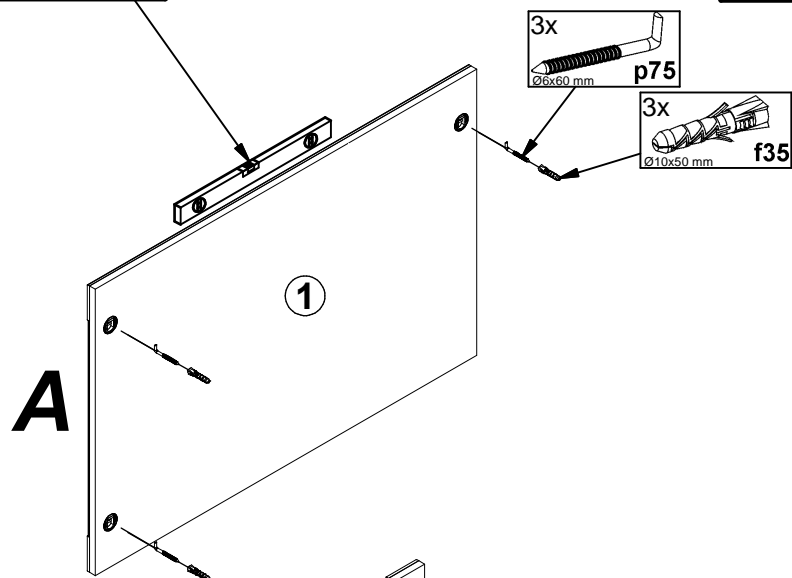

A

A

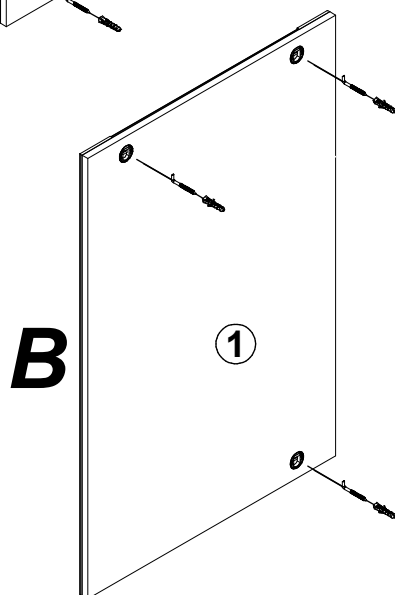

B

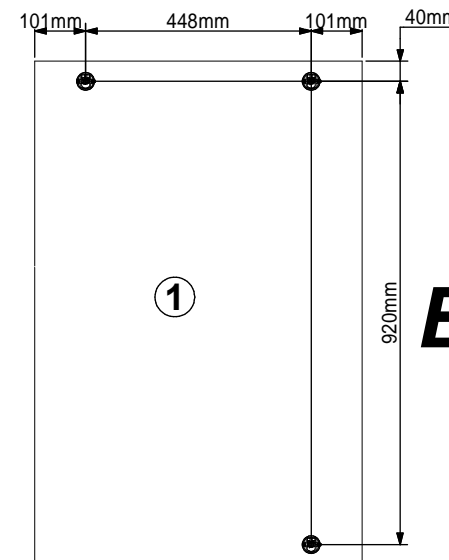
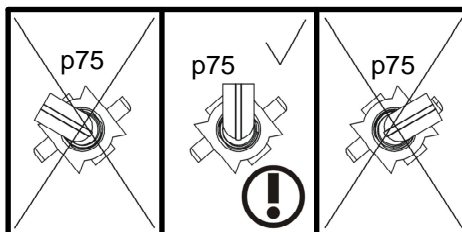

B