

B1	B2	C1	C2	C3	C4	D
S620-0017	-7	1888	196	16	1	1/2
S620-1041	-	1896	398	16	1	2/2
S620-1042	-	1896	382	16	1	2/2
S620-1043	-1	1896	346	16	1	1/2
S620-2023	-	701	400	18	1	2/2
S620-2024	-	701	400	18	1	2/2
S620-3028	-	365	346	16	1	2/2
S620-3029	-	286	340	16	1	1/2
S620-3030	-	364	340	16	3	1/2
S620-3031	-	285	340	16	3	1/2
S620-5060	-9	1888	22	16	5	1/2
S620-7005	-9	1888	250	16	1	1/2
S620-9010	-	1906	299	2,5	1	2/2
S620-9011	-	1906	377	2,5	1	2/2

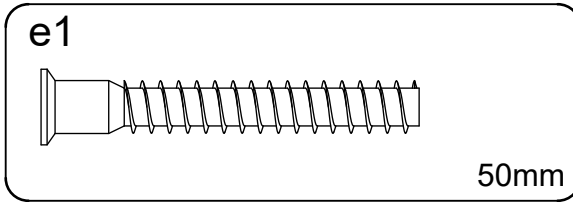

1:1

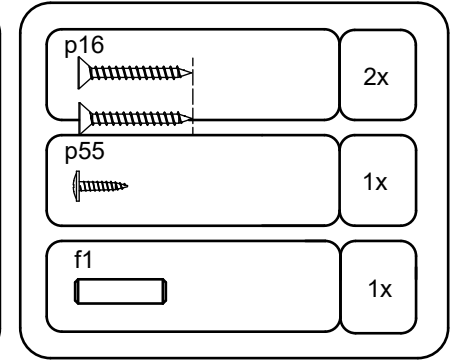
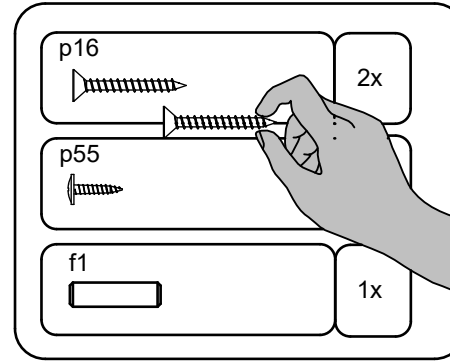

12x

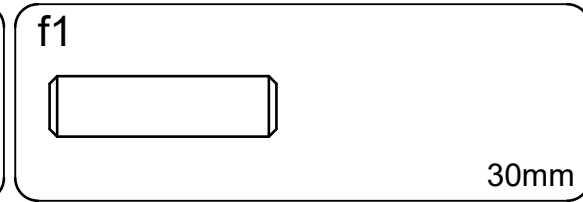

20x



10x



16x

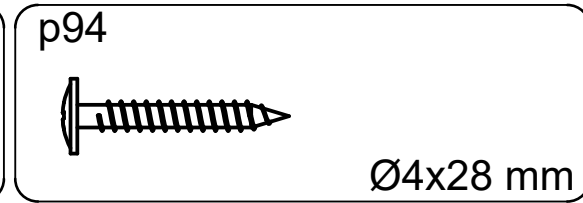

8x

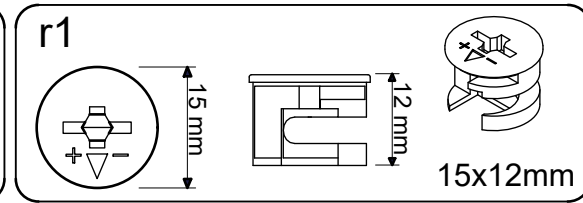

8x

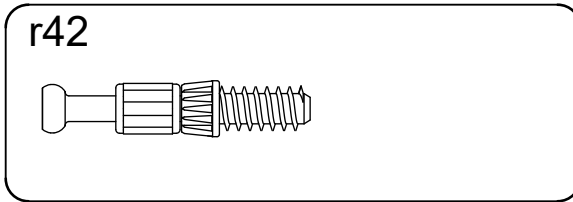

8x

~~1:1~~

a83

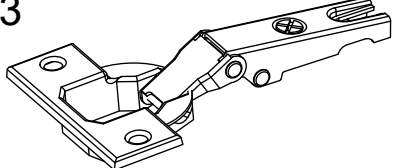

4x

b42

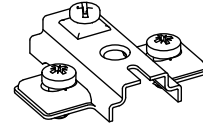

4x

d1

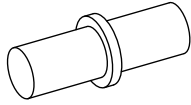

fi5mm

24x

f88

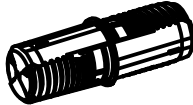

25x

k27

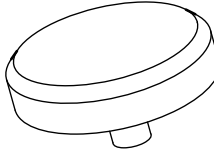

fi48x19mm

5x

l2

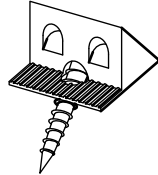

16x

n14\2

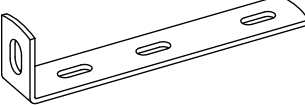

1x

n108

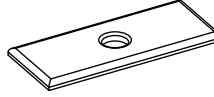

12x

o21

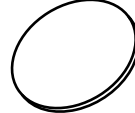

∅8/1,8mm

3x

z1

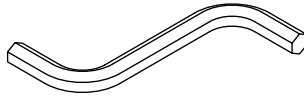

4mm

1x

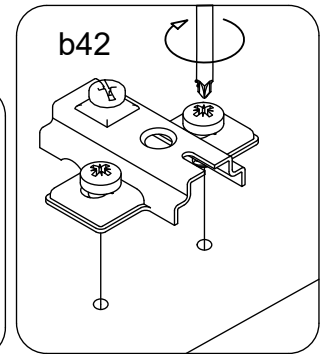
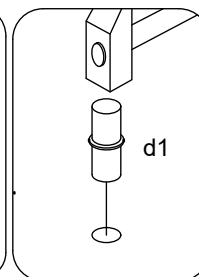
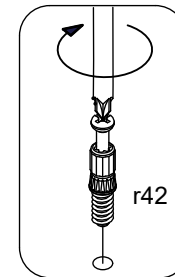
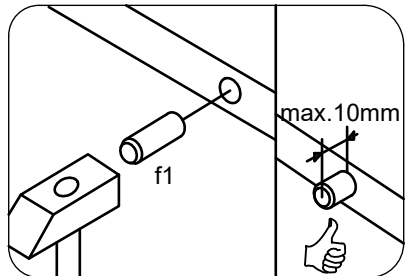
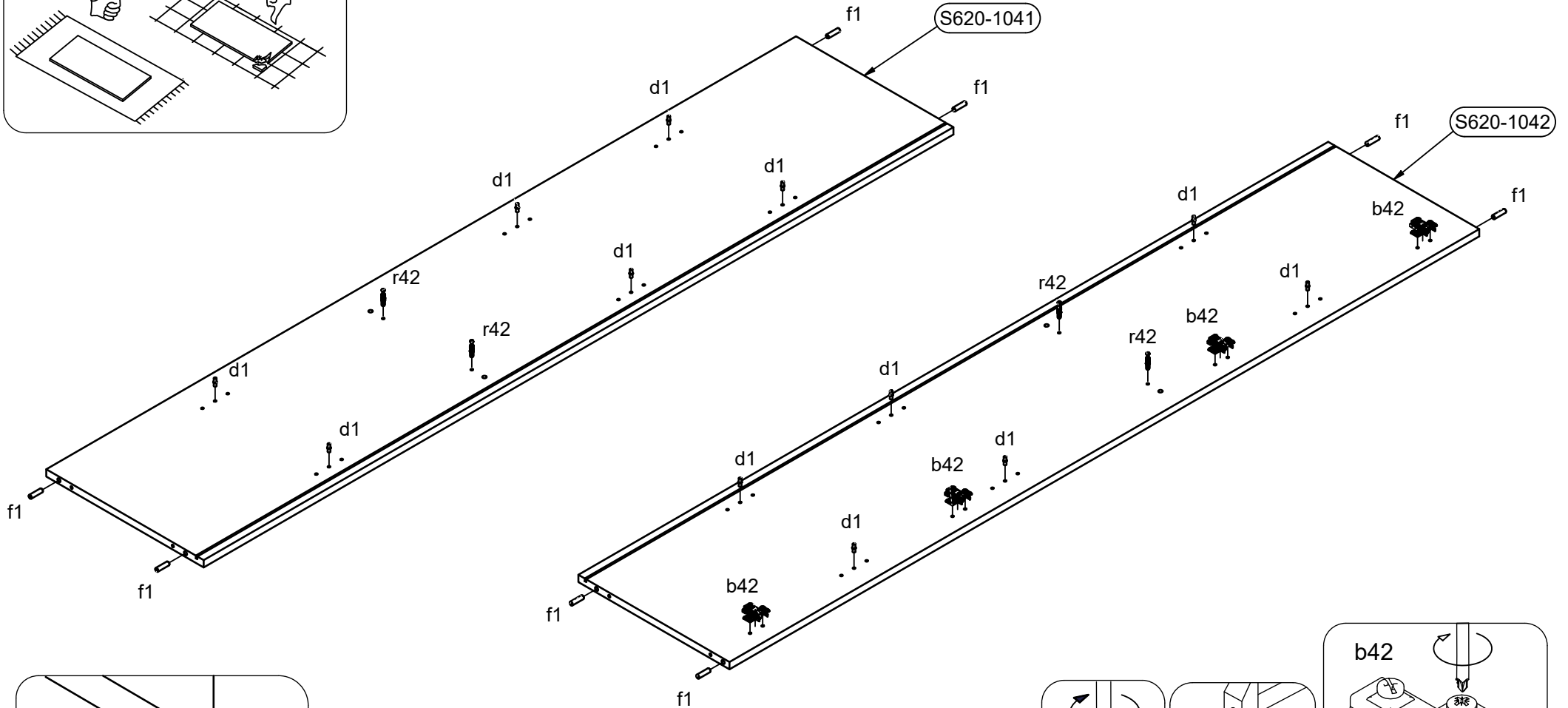
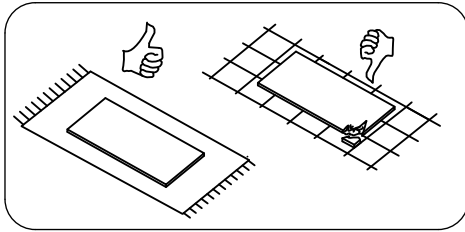
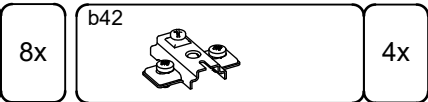
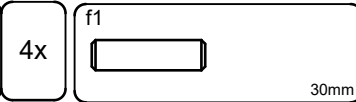
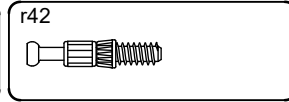
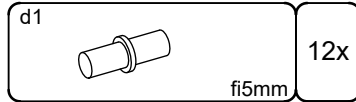

2 

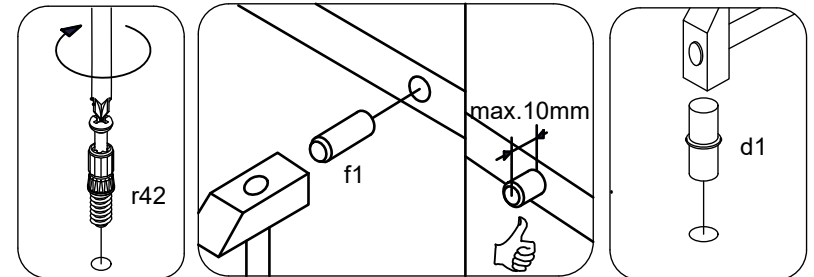
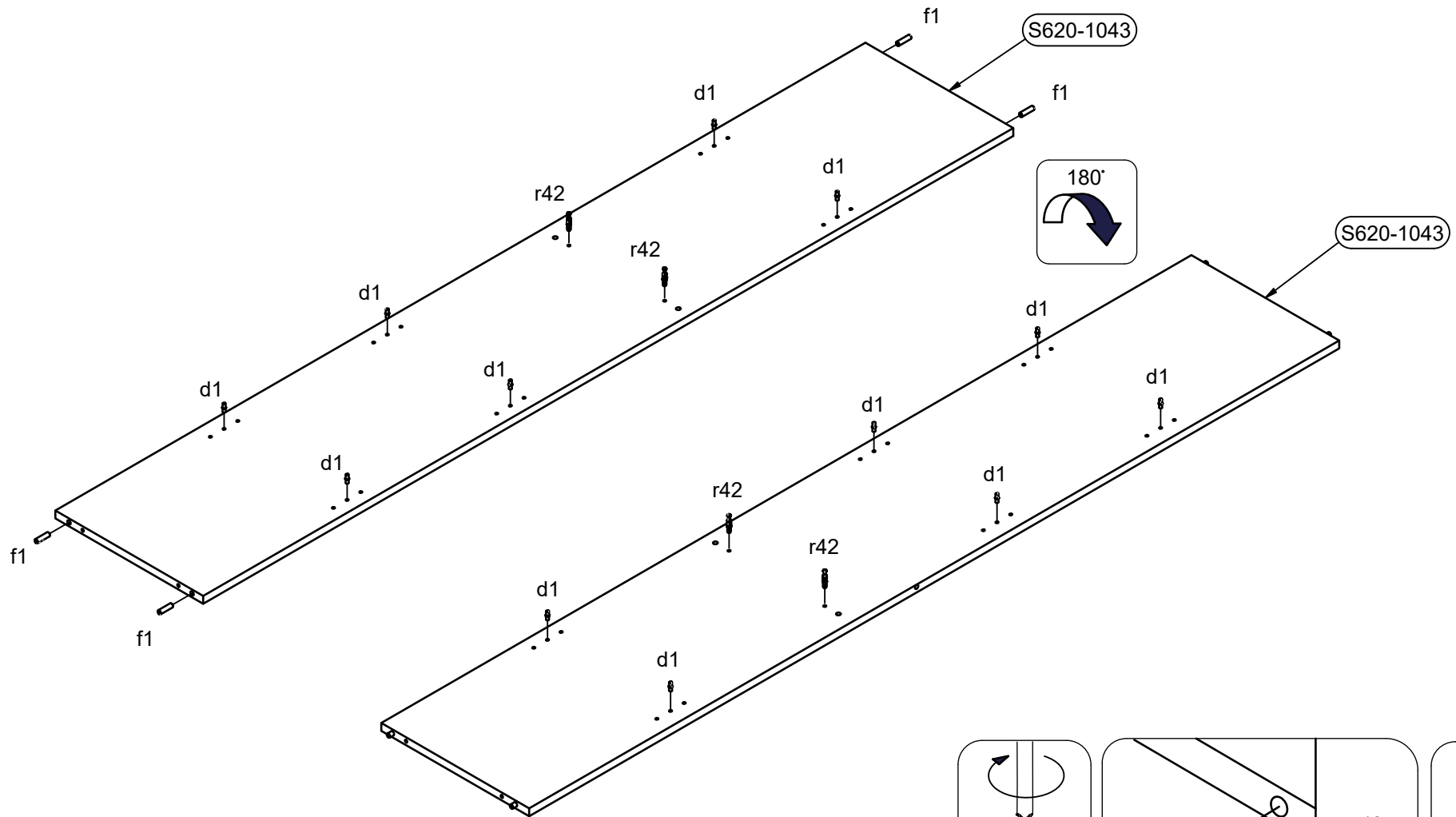
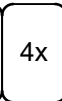
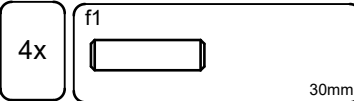
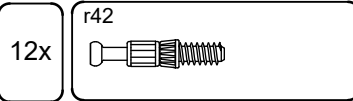
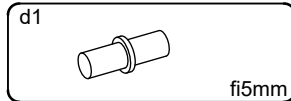

3

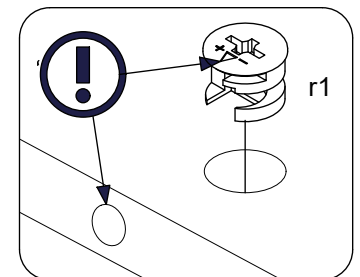
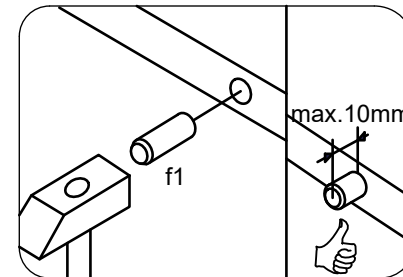
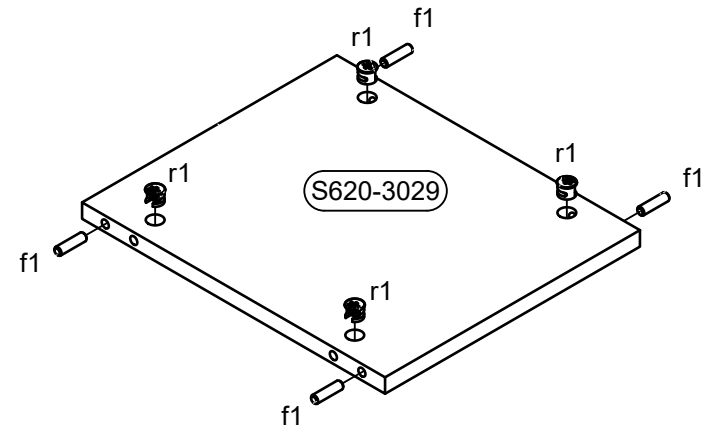
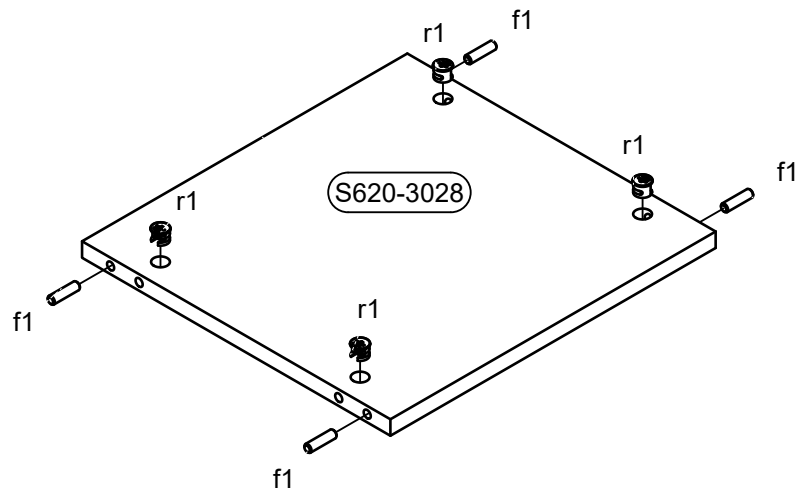
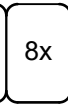
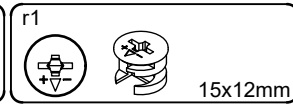
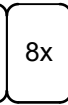
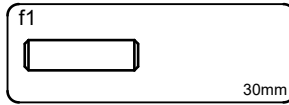

4

f88



25

p51



3.5x15mm

8x

p94



Ø4x28 mm

8x

a83

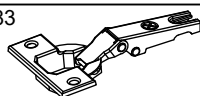

4x

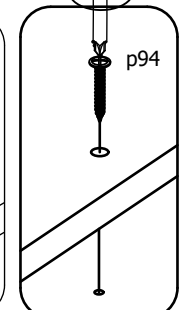
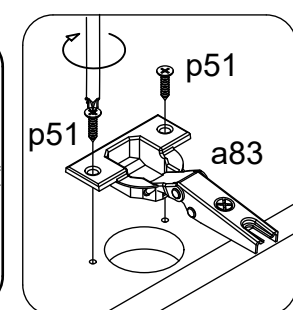
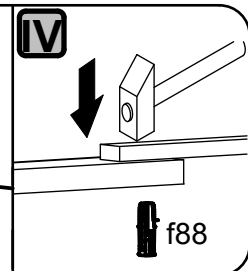
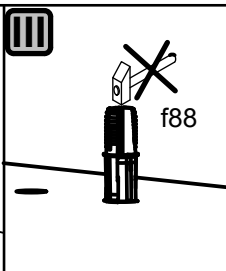
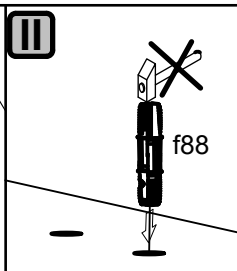
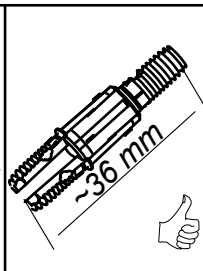
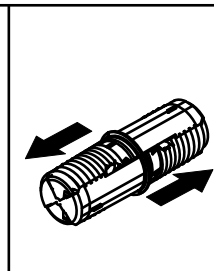
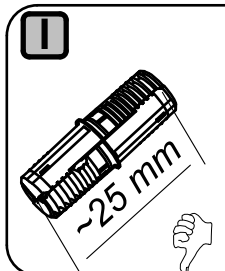
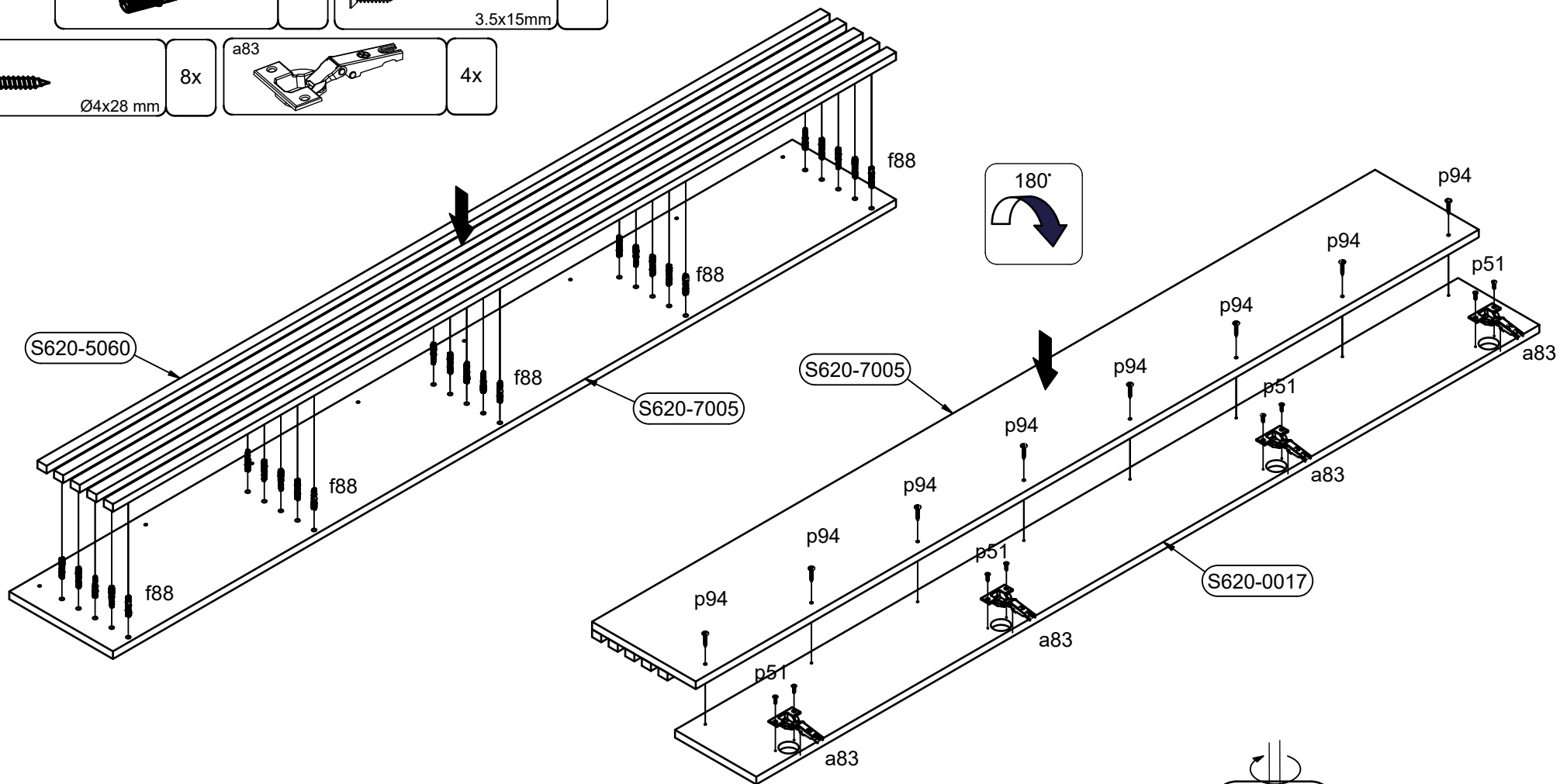

5

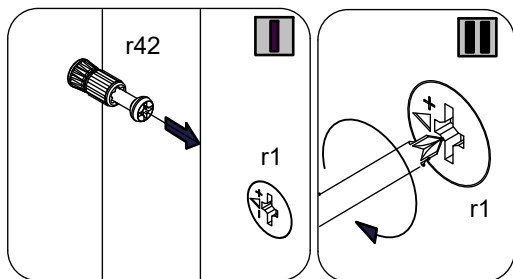
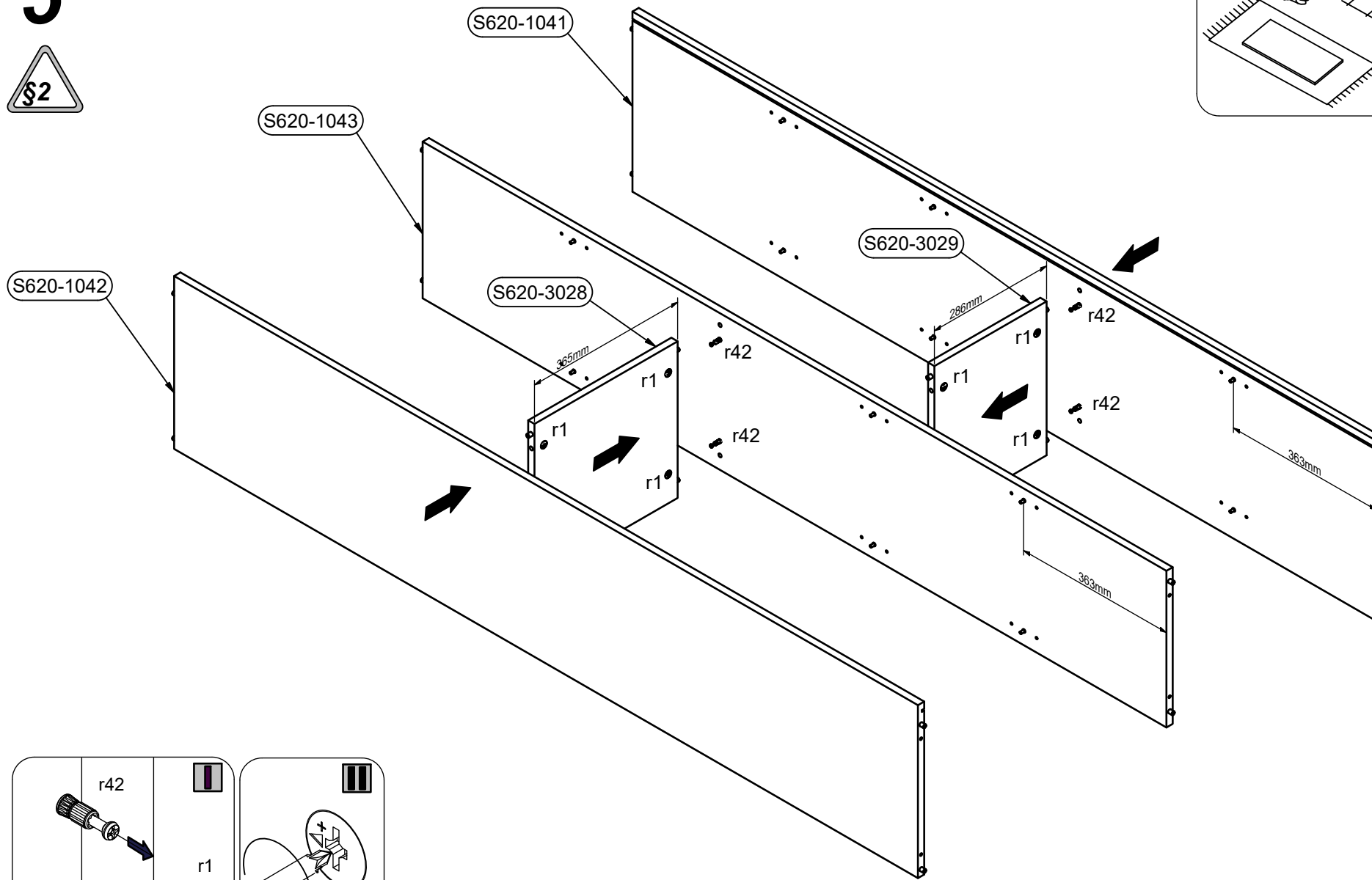
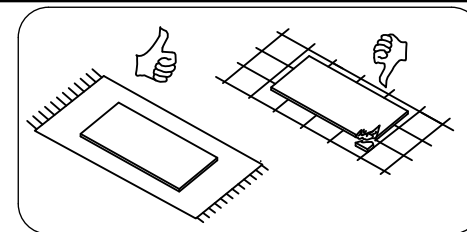

6

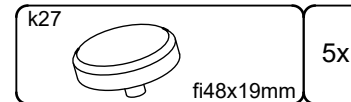
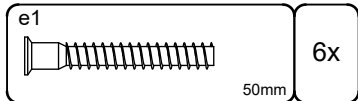

7

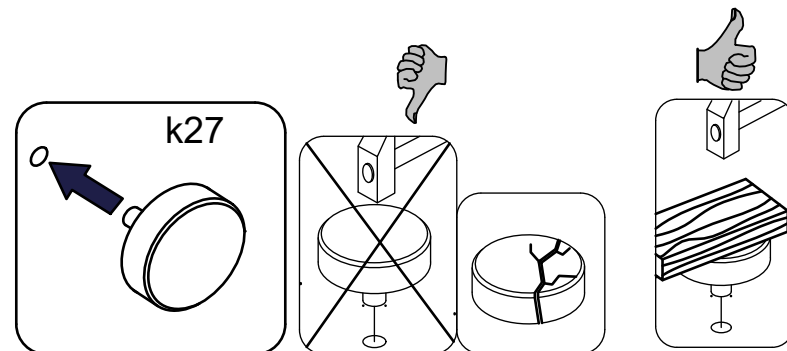
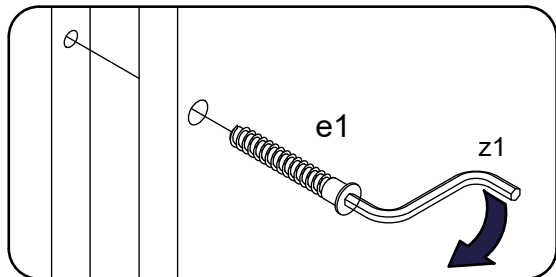
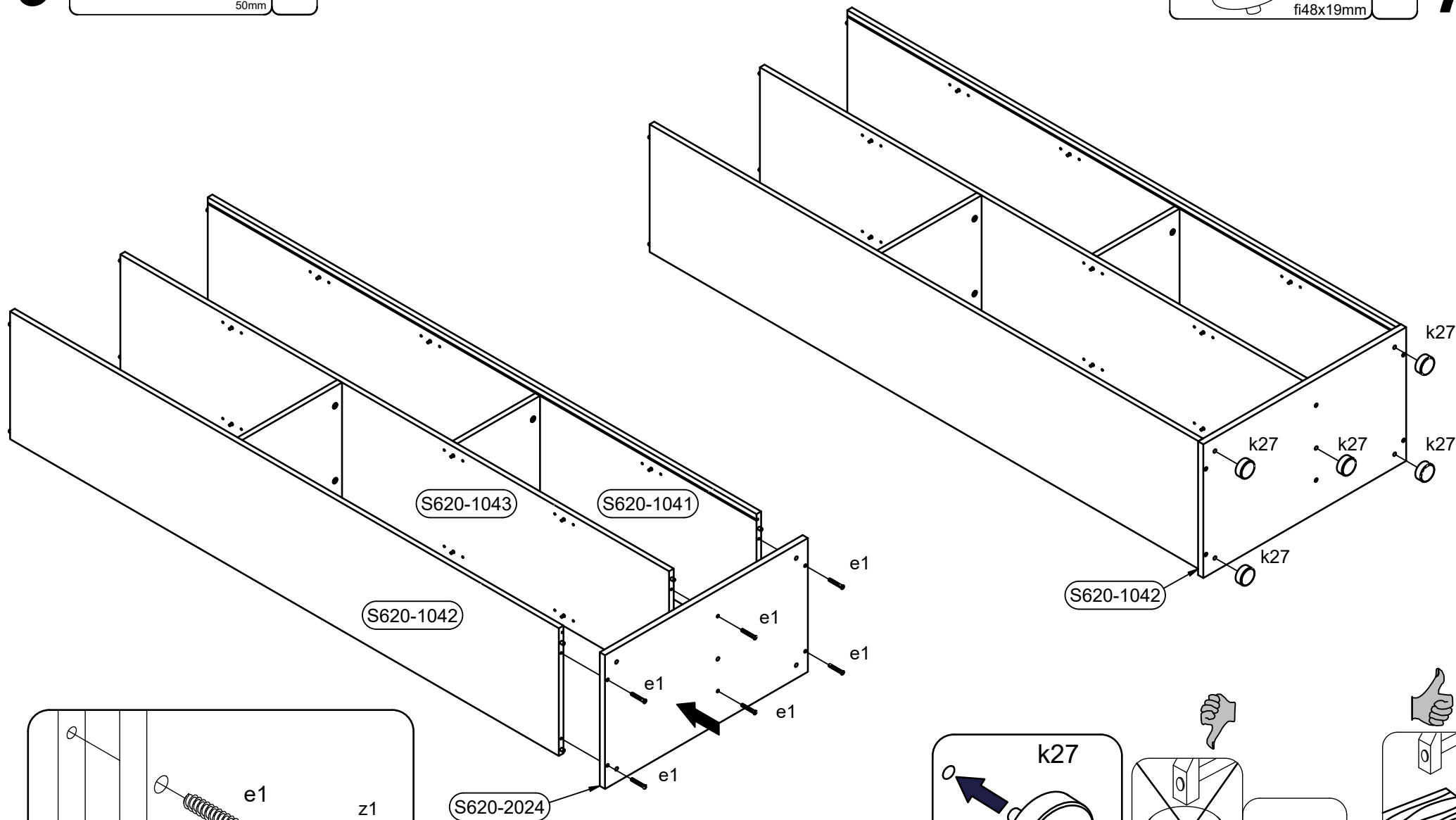

8

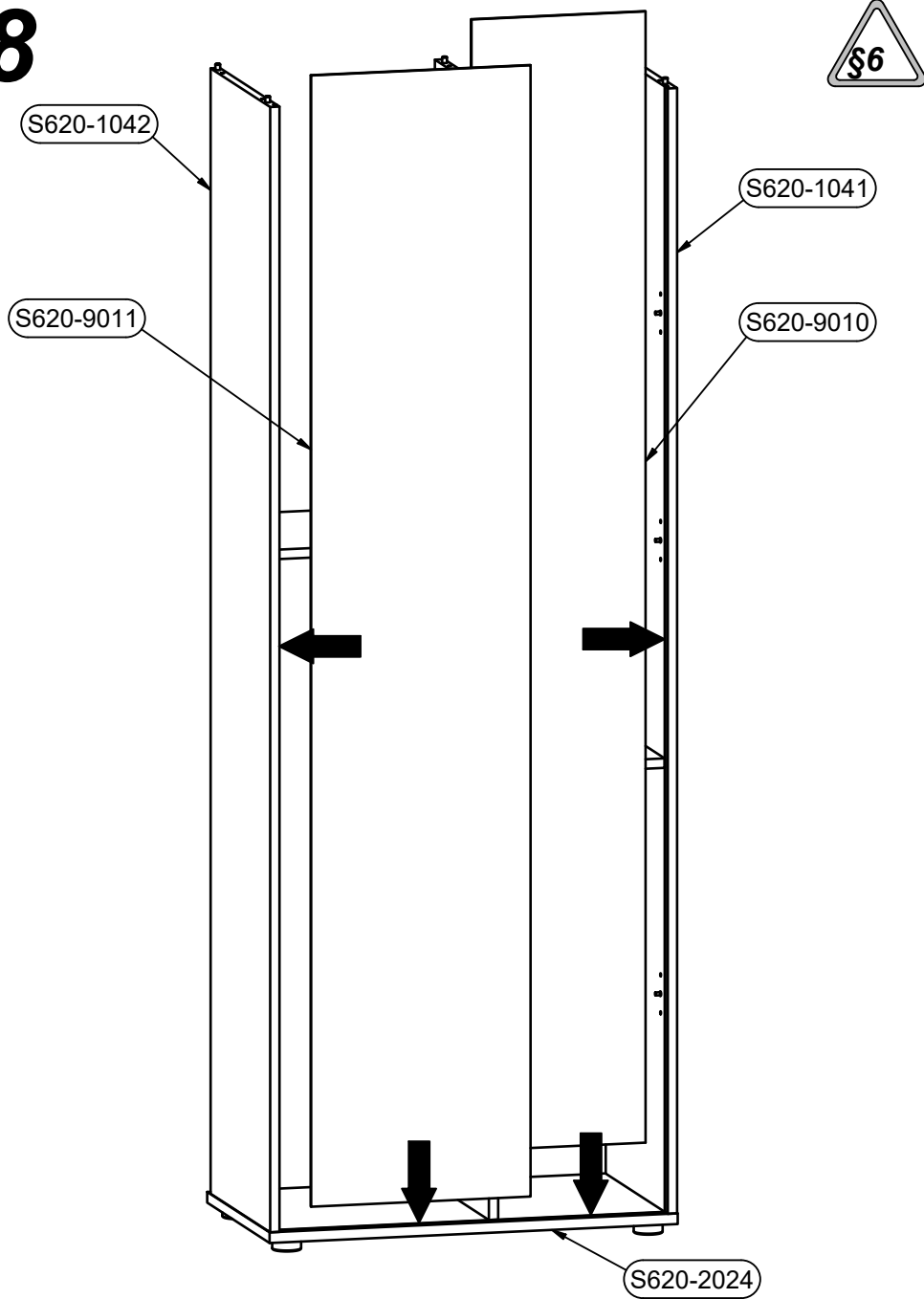

9

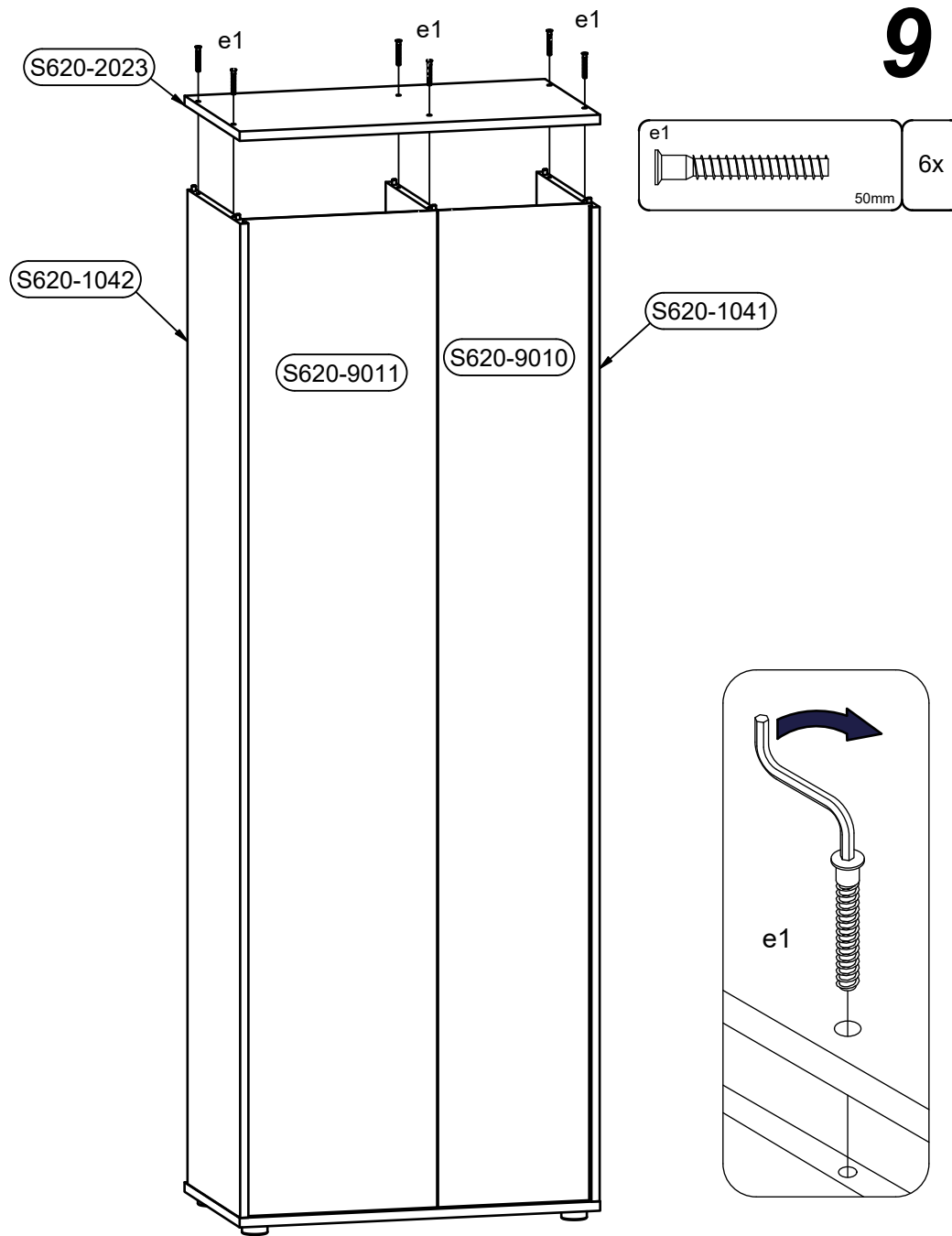

10



l2 	16x	n108 	12x	p55 	16x 2.8x16mm
--------	-----	----------	-----	---------	-----------------

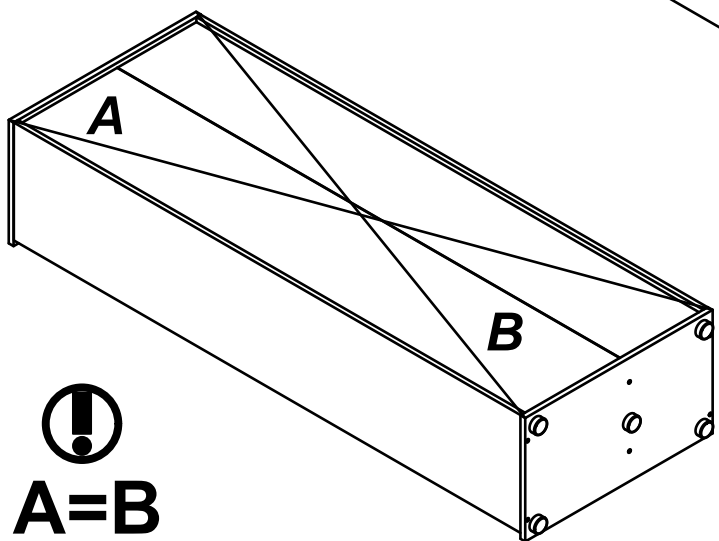
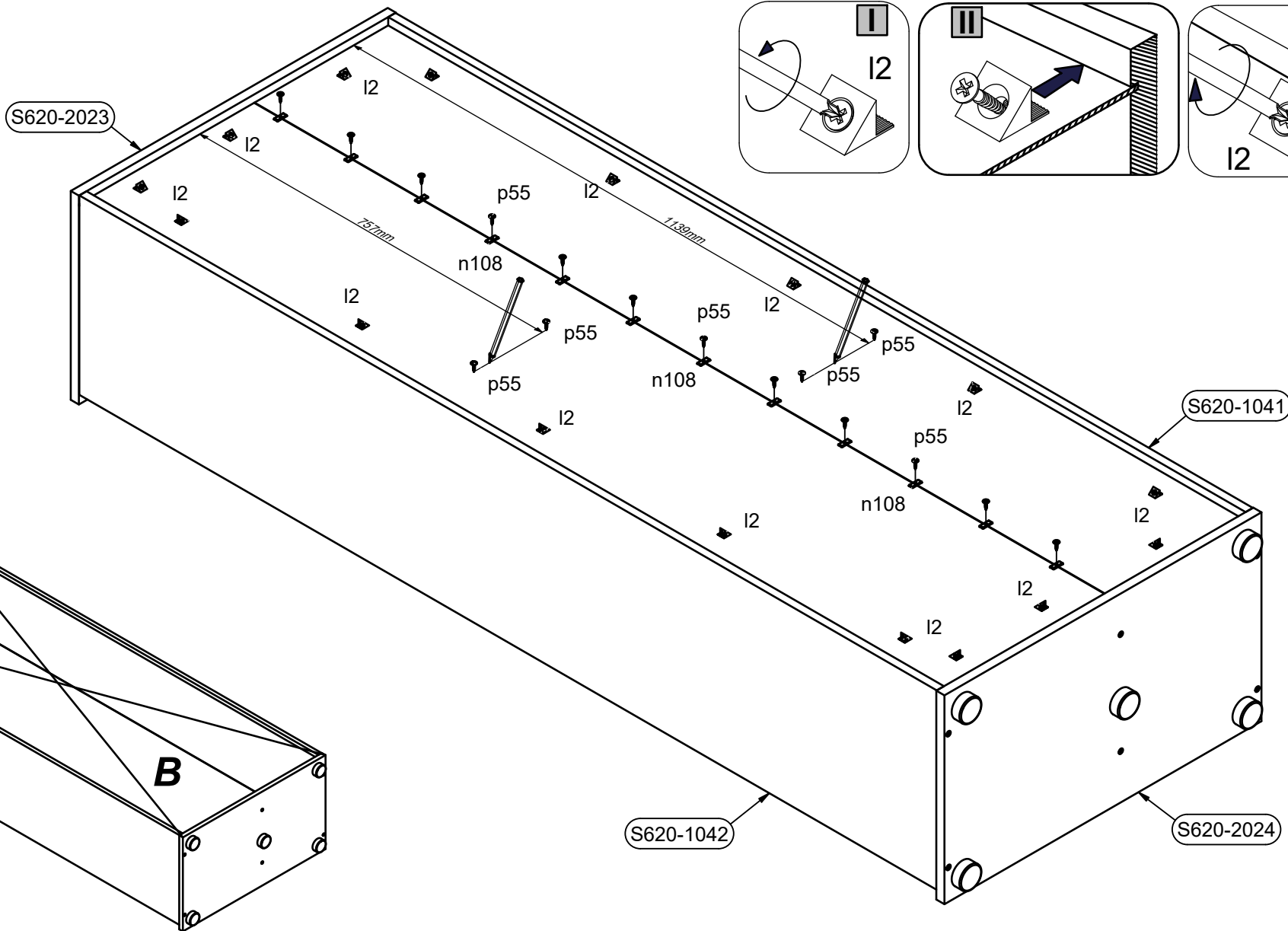
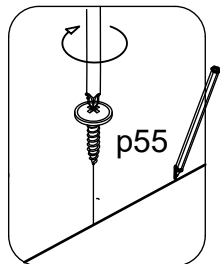
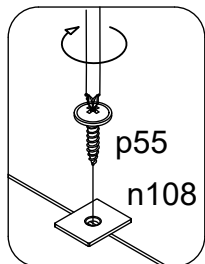

A=B

11

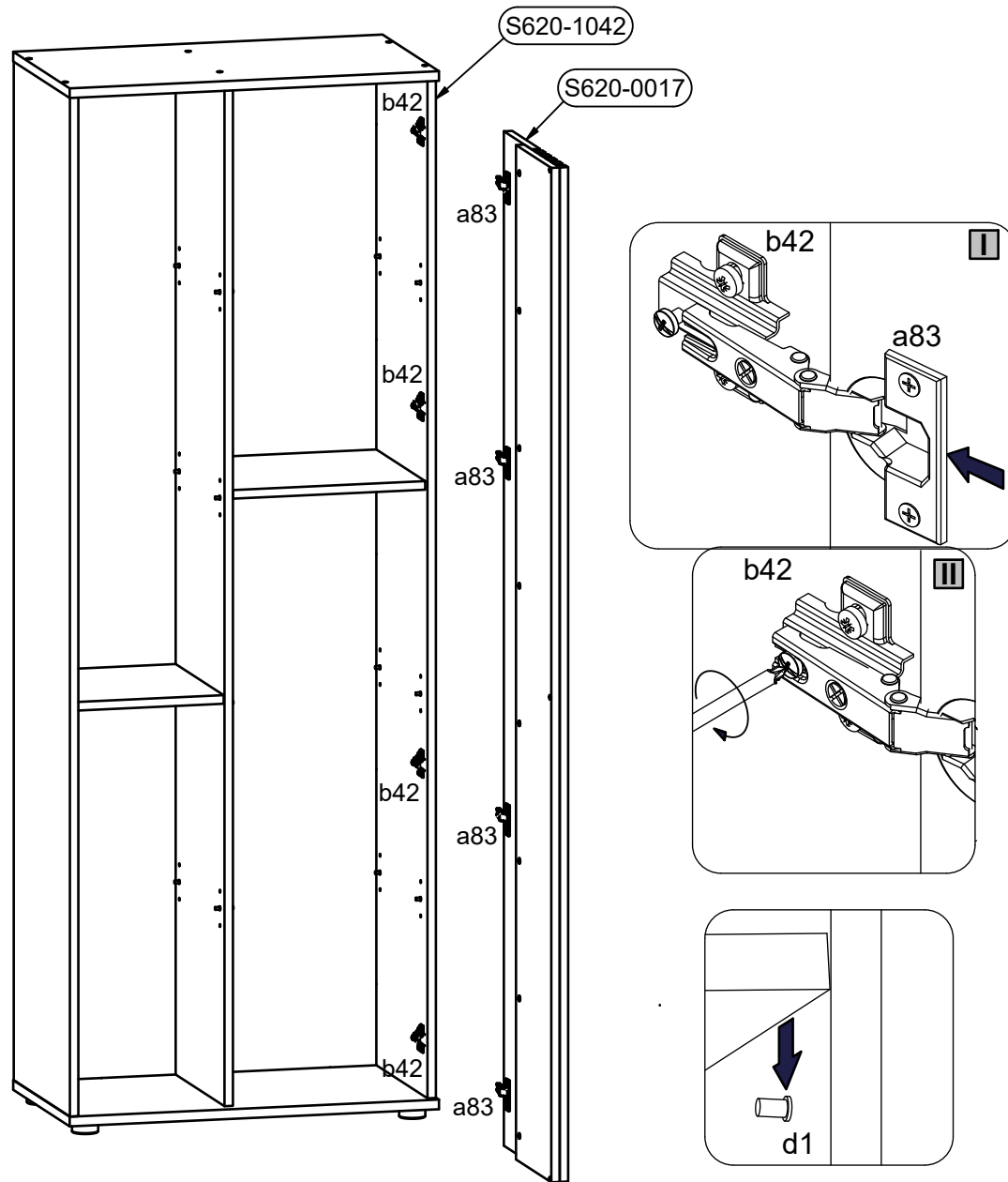

12

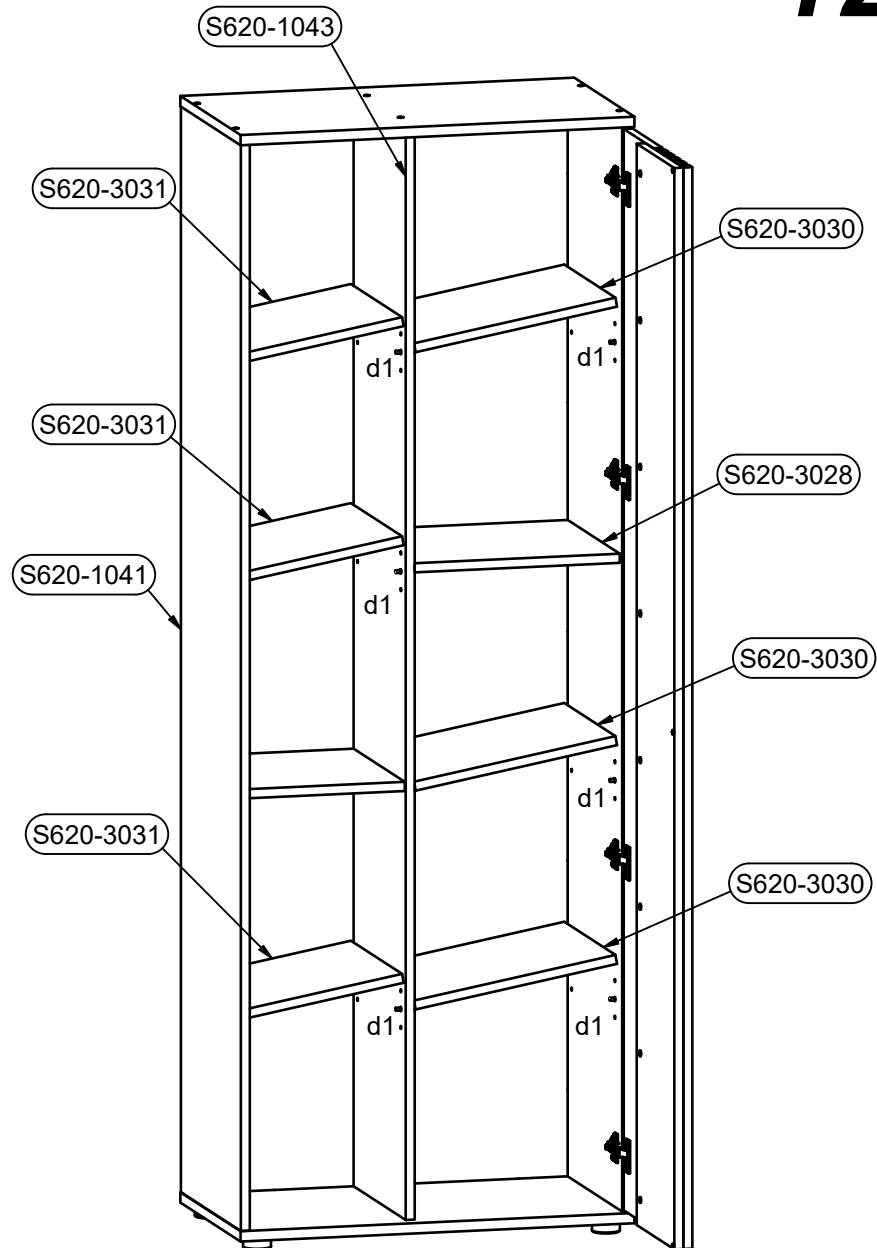

13

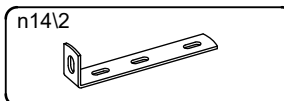

1x

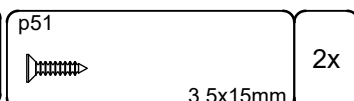

2x

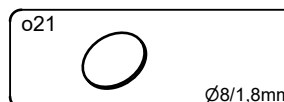

3x

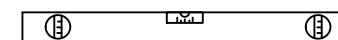
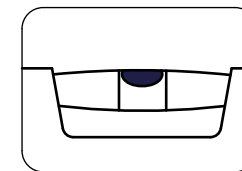
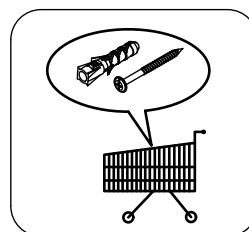

n14\2 p51

S620-2023

S620-0017

