

	B1	B2	C1	C2	C3	C4	D
S620-0012	-9	1308	196	16	1	1	2/2
S620-0014	-7	600	496	16	1	1	1/2
S620-1012	-8	1316	382	16	1	1	2/2
S620-1044	-	1316	382	16	1	1	2/2
S620-1045	-	1316	362	16	1	1	2/2
S620-2025	-	901	400	18	1	1	1/2
S620-2026	-	901	400	18	1	1	1/2
S620-3006	-7	466	358	16	1	1	1/2
S620-3007	-8	384	346	16	3	3	1/2
S620-3032	-	465	340	16	3	3	1/2
S620-5062	-.15	1308	22	16	5	5	2/2
S620-7004	-.14	1308	250	16	1	1	2/2
S620-9006	-8	1326	398	2,5	1	1	2/2
S620-9304	-9	1326	479	2,5	1	1	2/2

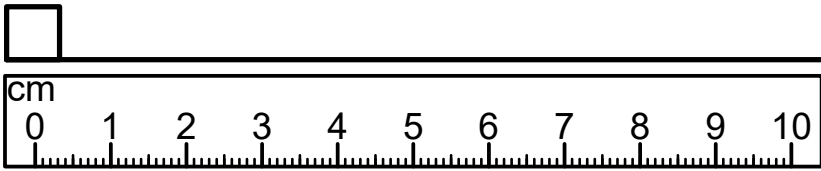

1:1

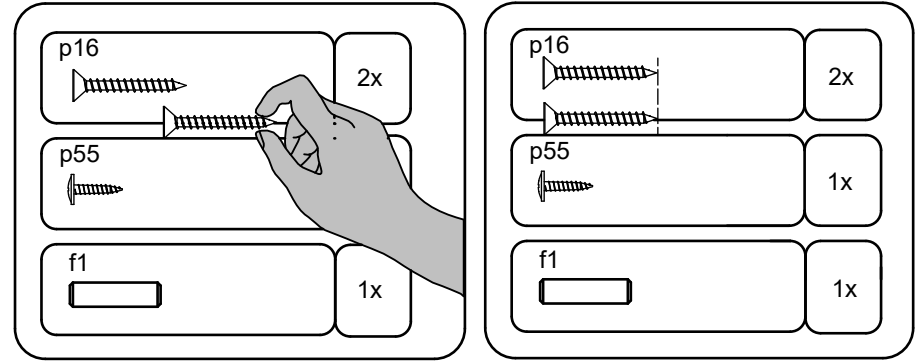

<p>d4</p> <p>Ø6.3x15 mm</p>	<p>2x</p>	<p>e1</p> <p>50mm</p>	<p>6x</p>	<p>f1</p> <p>30mm</p>	<p>16x</p>
<p>p51</p> <p>3.5x15mm</p>	<p>12x</p>	<p>p55</p> <p>2.8x16mm</p>	<p>12x</p>	<p>p94</p> <p>Ø4x28 mm</p>	<p>6x</p>
<p>p140</p> <p>Ø3.5x12 mm</p>	<p>2x</p>	<p>r1</p> <p>15 mm</p> <p>12 mm</p> <p>15x12mm</p>	<p>10x</p>	<p>r42</p>	<p>10x</p>

~~1:1~~

a83

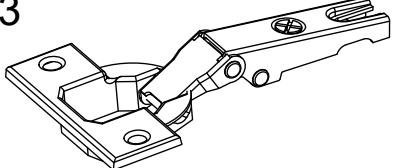

5x

b42

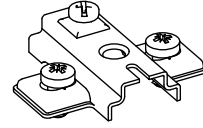

5x

c623\1

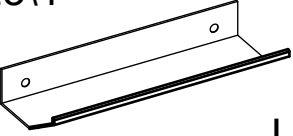

L84/64mm

1x

d1

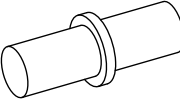

fi5mm

24x

f88



20x

k27

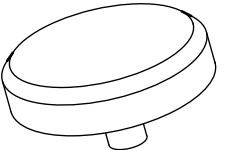

fi48x19mm

5x

l2

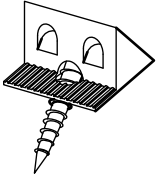

14x

n14\2

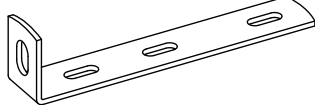

1x

n108

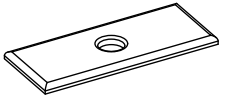

8x

o21

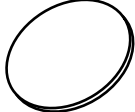

Ø8/1,8mm

2x

s68

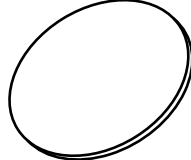

Ø20mm

6x

z1

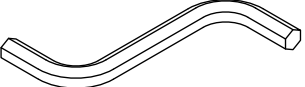

4mm

1x

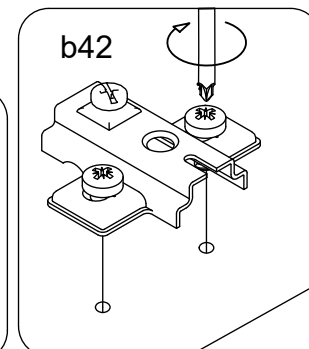
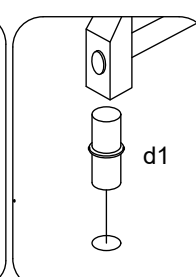
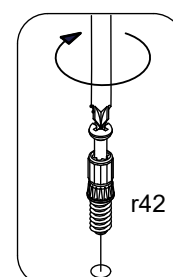
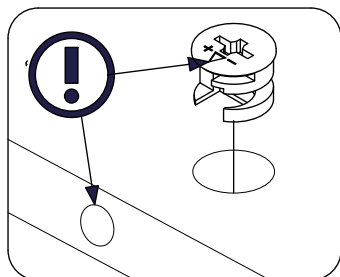
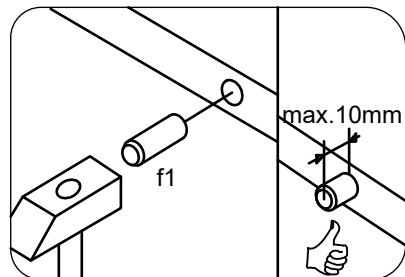
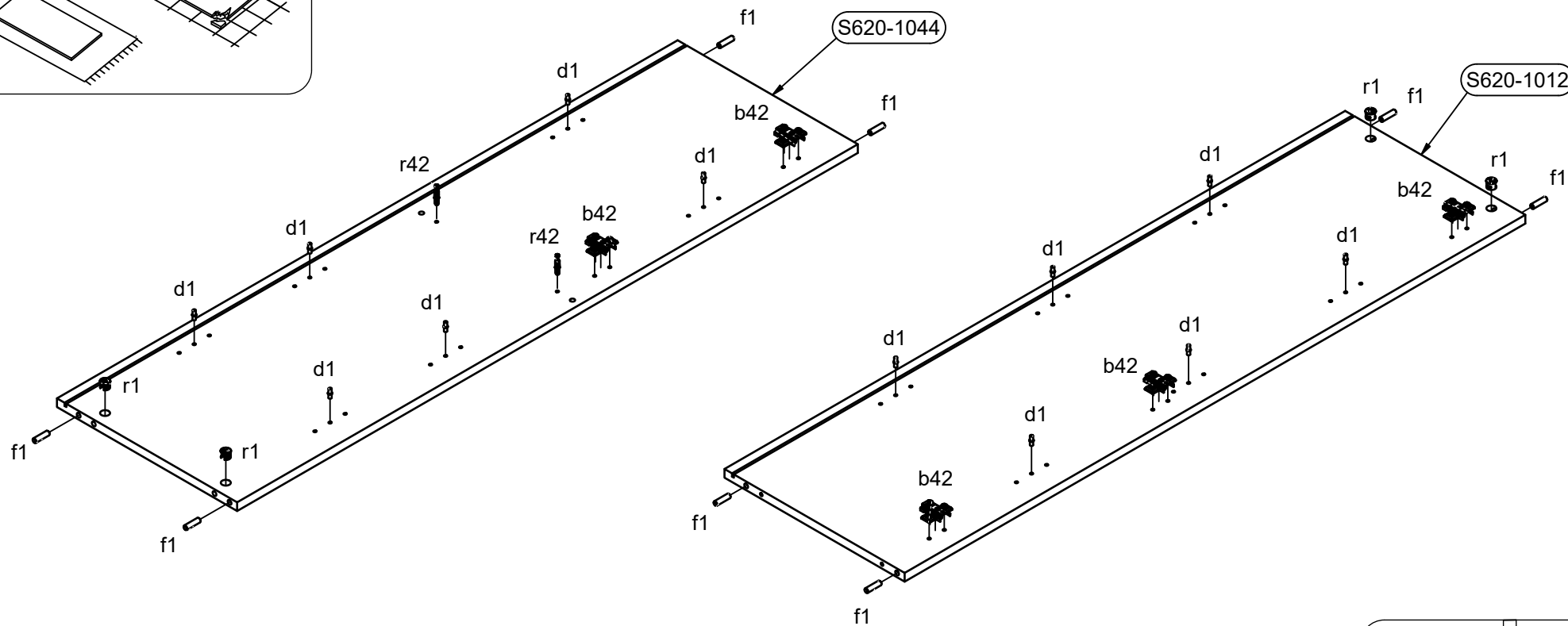
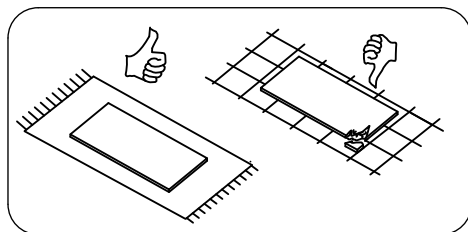
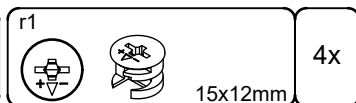
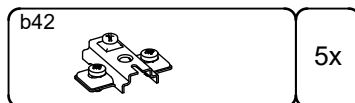
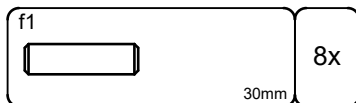
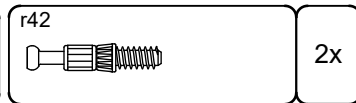
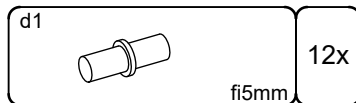

2

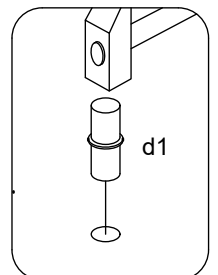
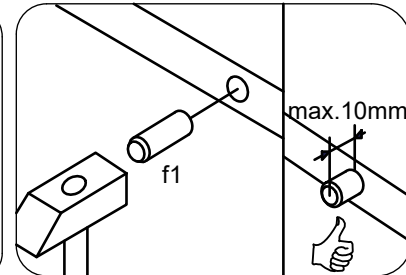
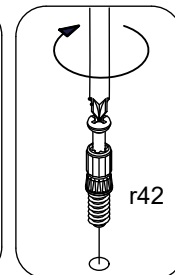
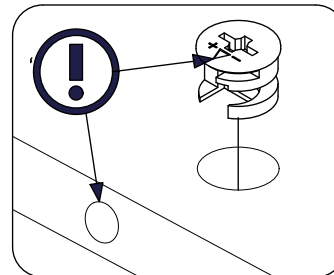
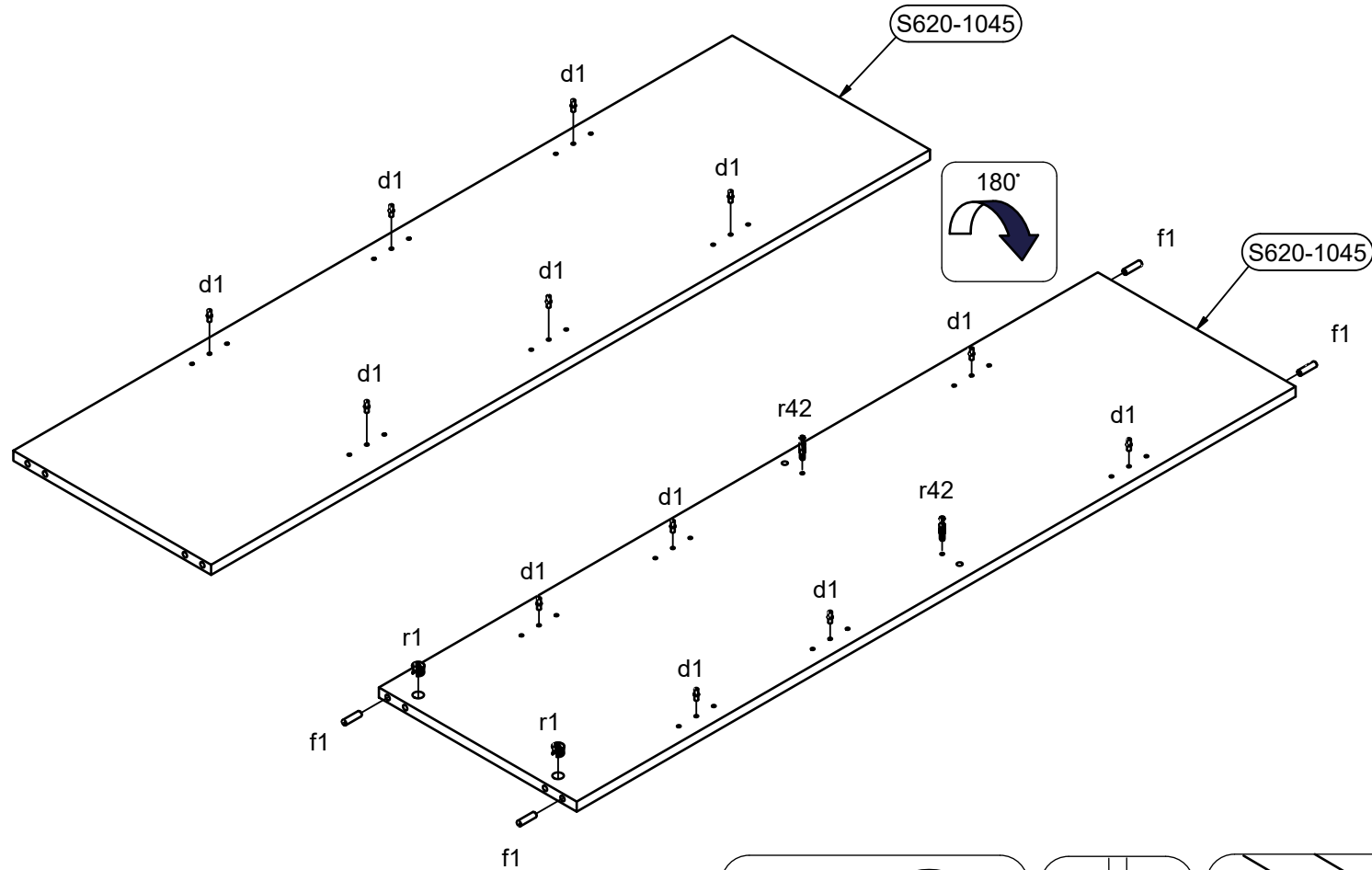
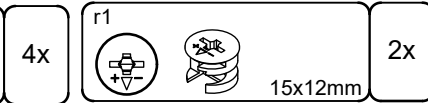
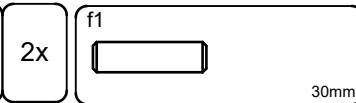
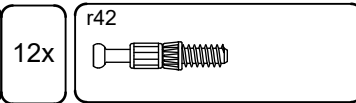
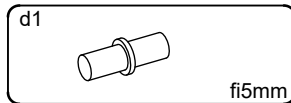

3

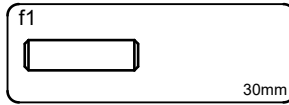

4x

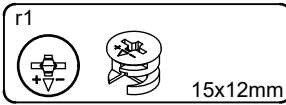

4x

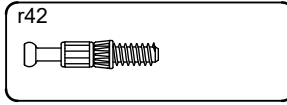

6x

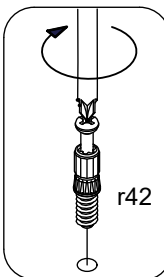
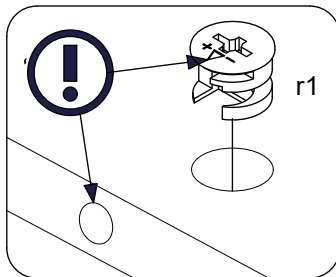
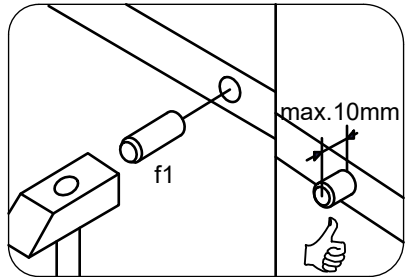
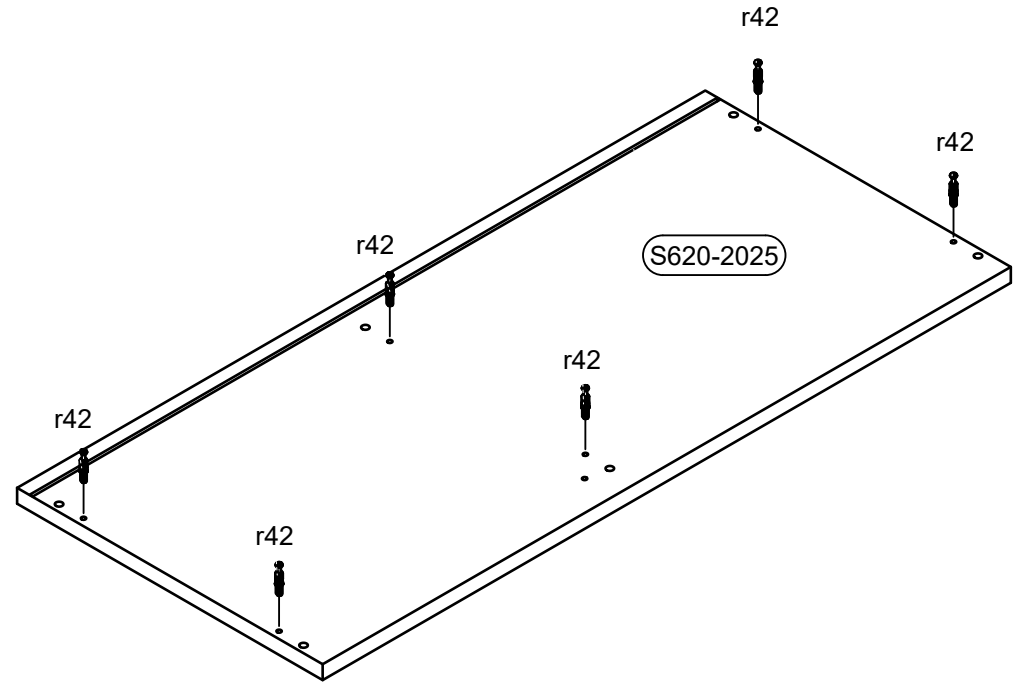
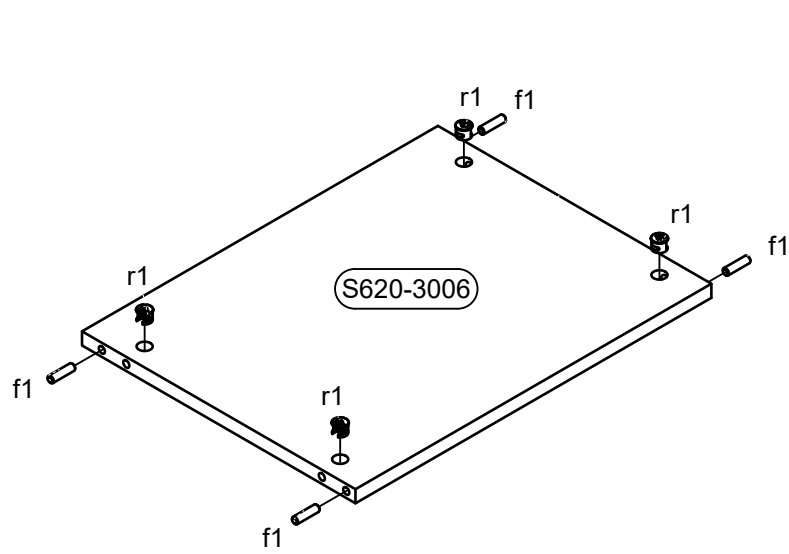
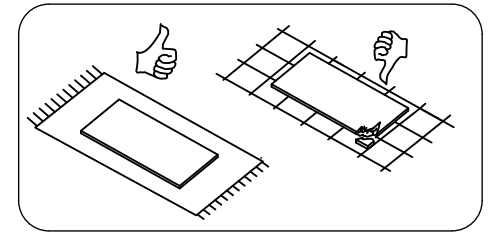

4

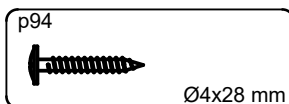

6x

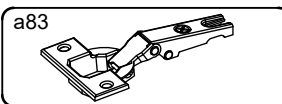

3x

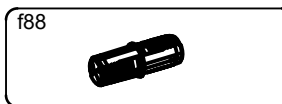

20x

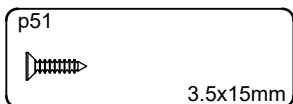

6x

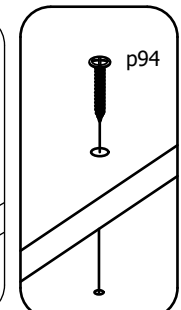
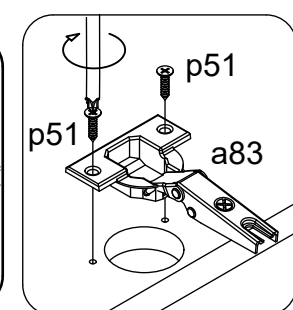
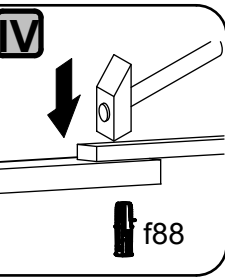
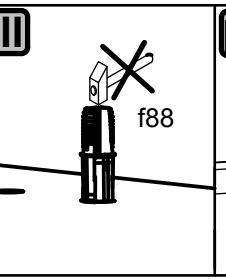
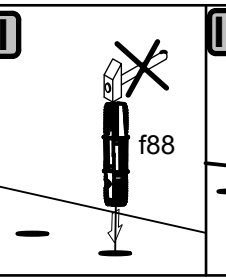
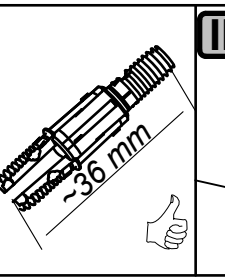
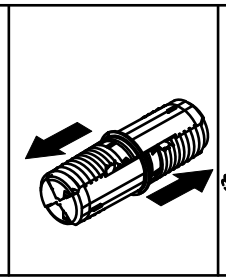
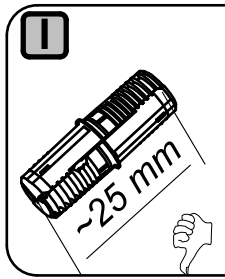
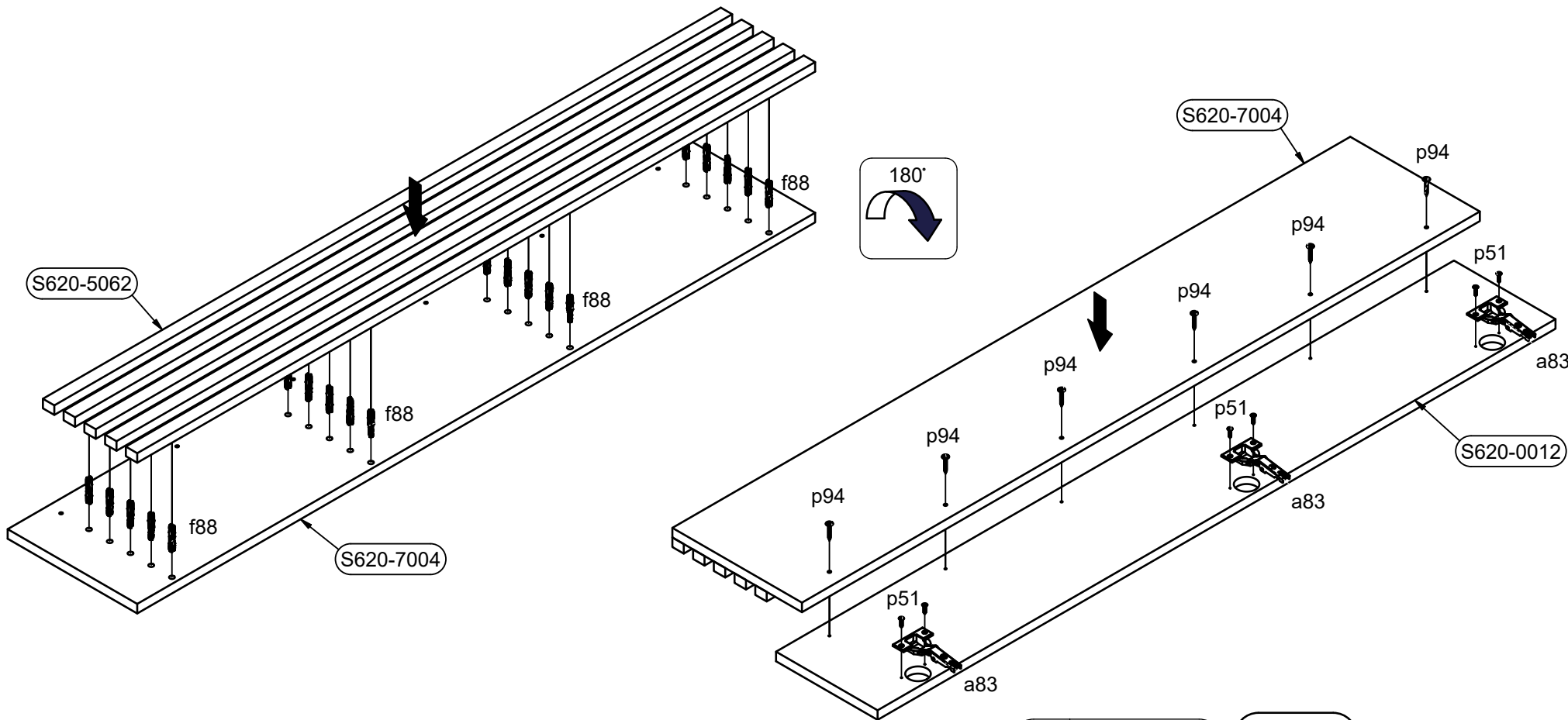

5

a83

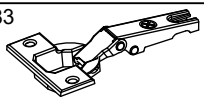

2x

p51



3.5x15mm

4x

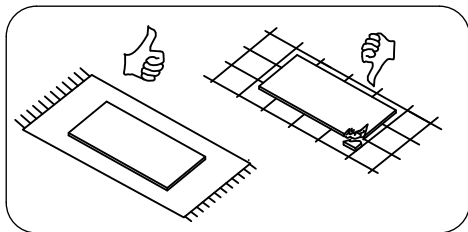

S620-0014

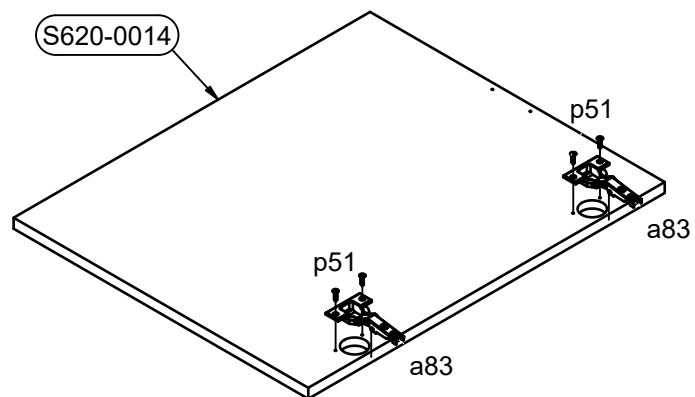

p51

a83

p51

a83

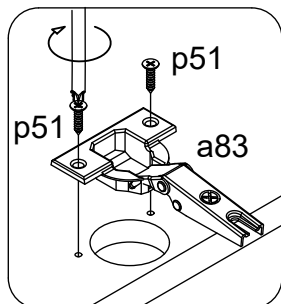

p51

p51

a83

6

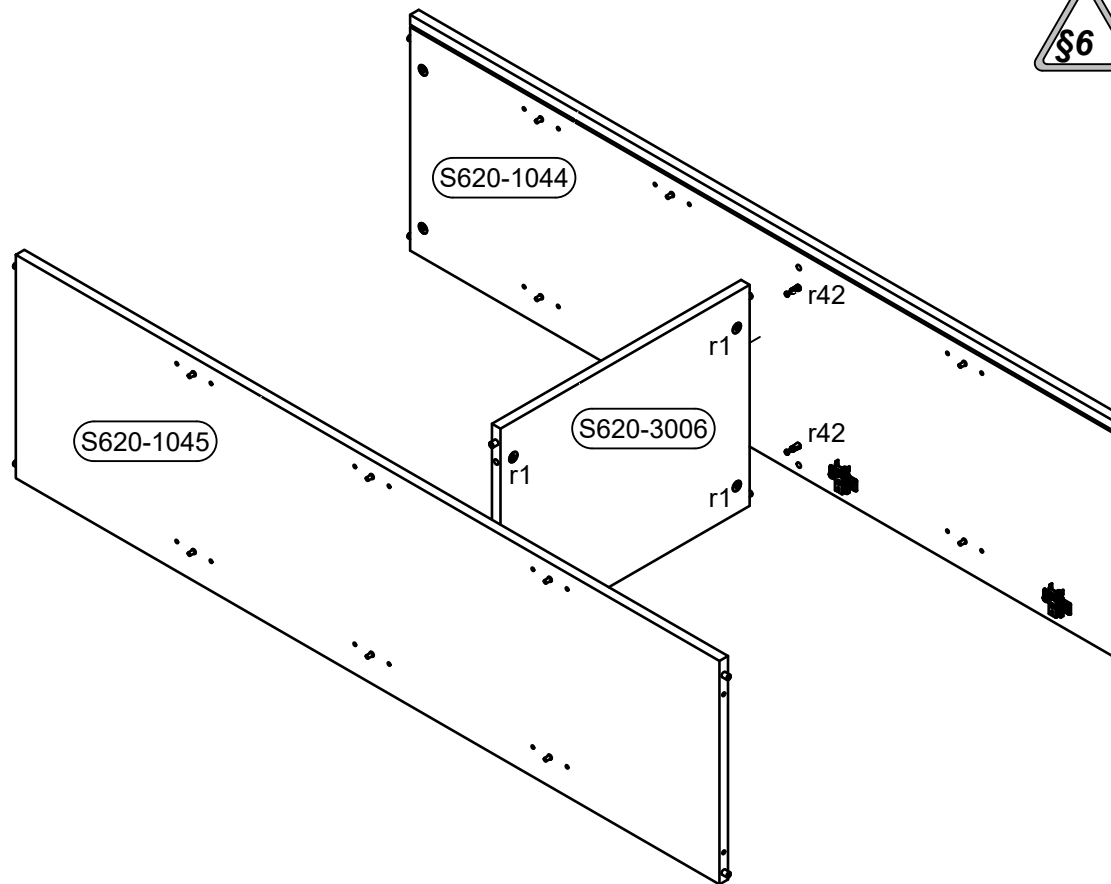

S620-1044

S620-1045

S620-3006

r42

r1

r1

r1

r42



r42

r1

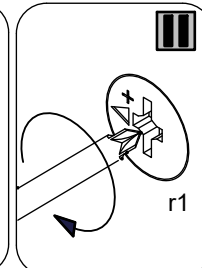

r1

7

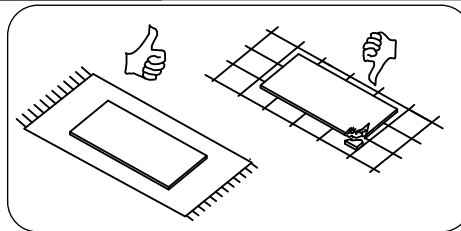

8

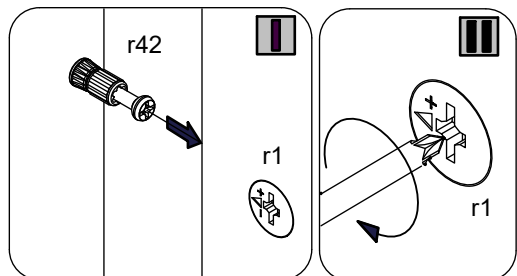
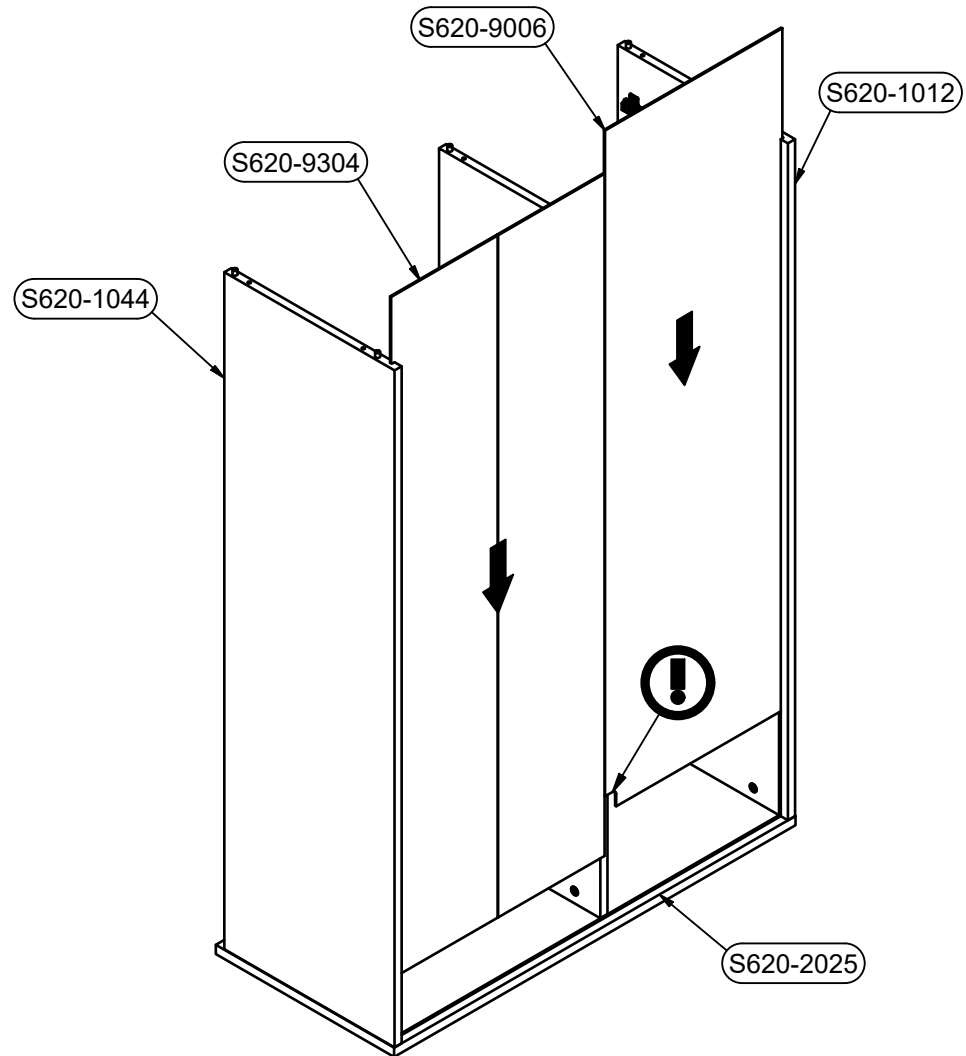
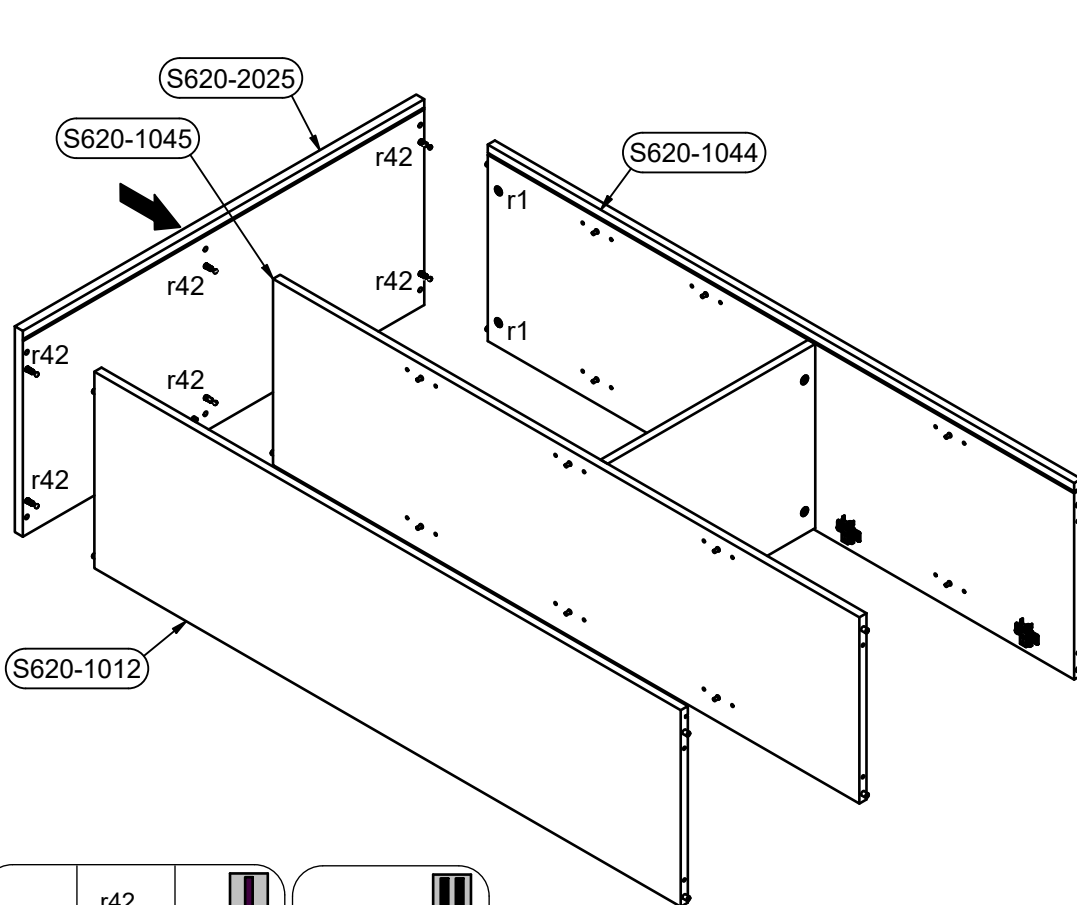

9

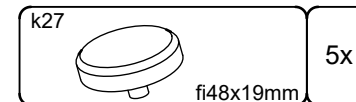
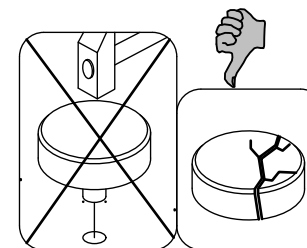
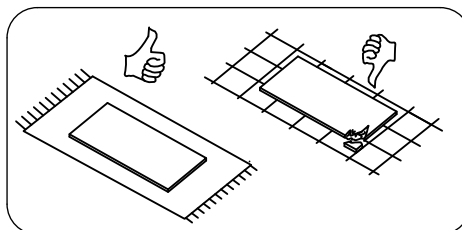
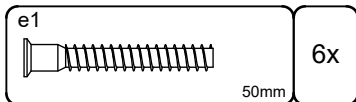

10

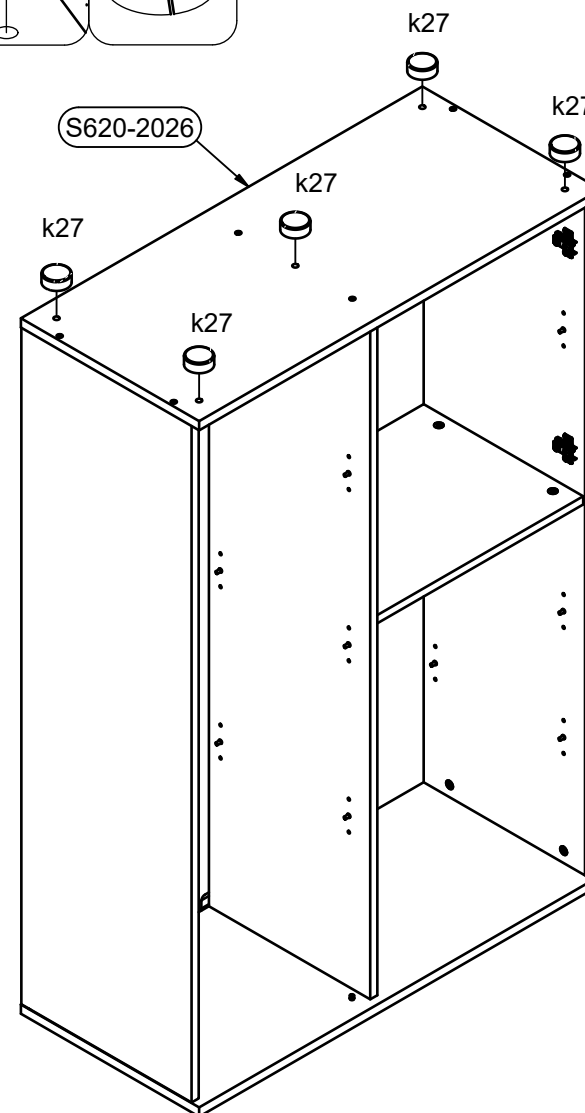
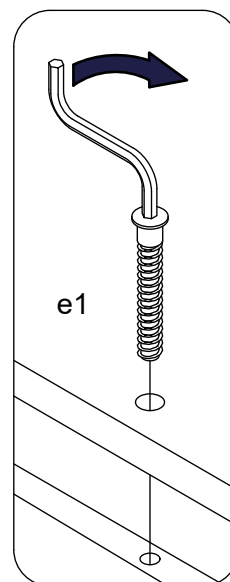
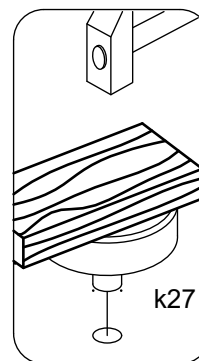
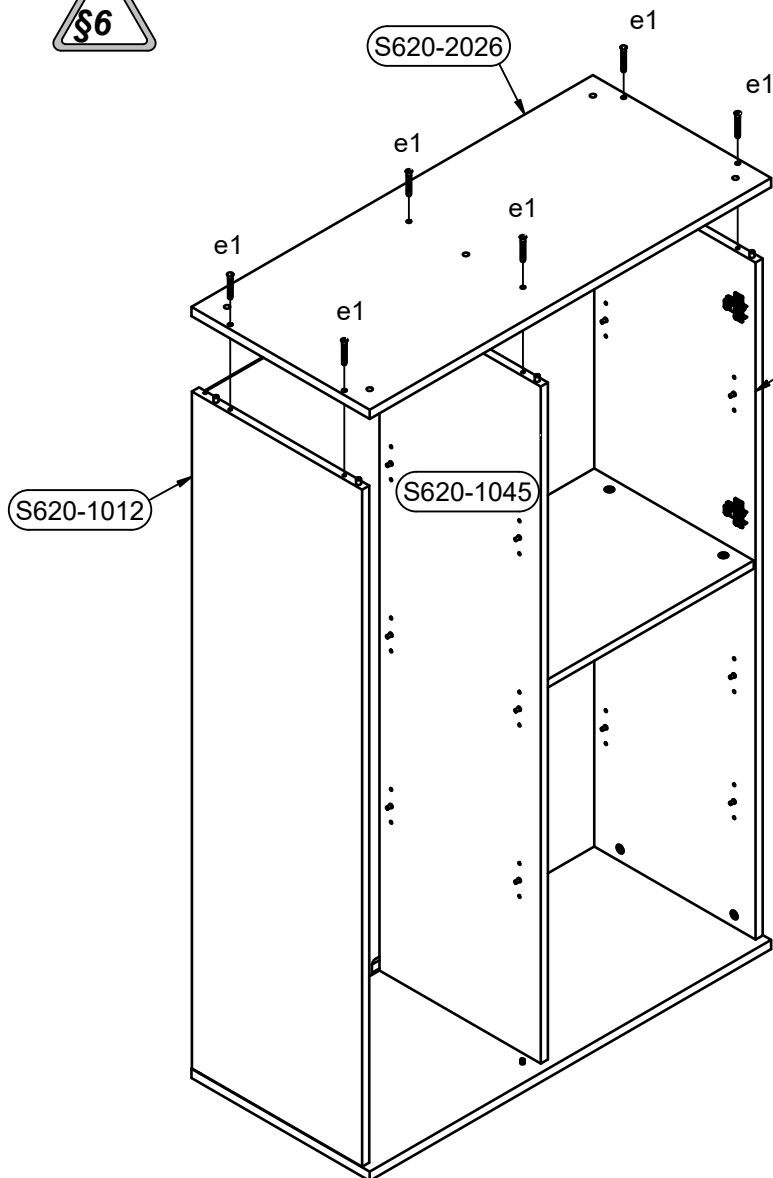

11



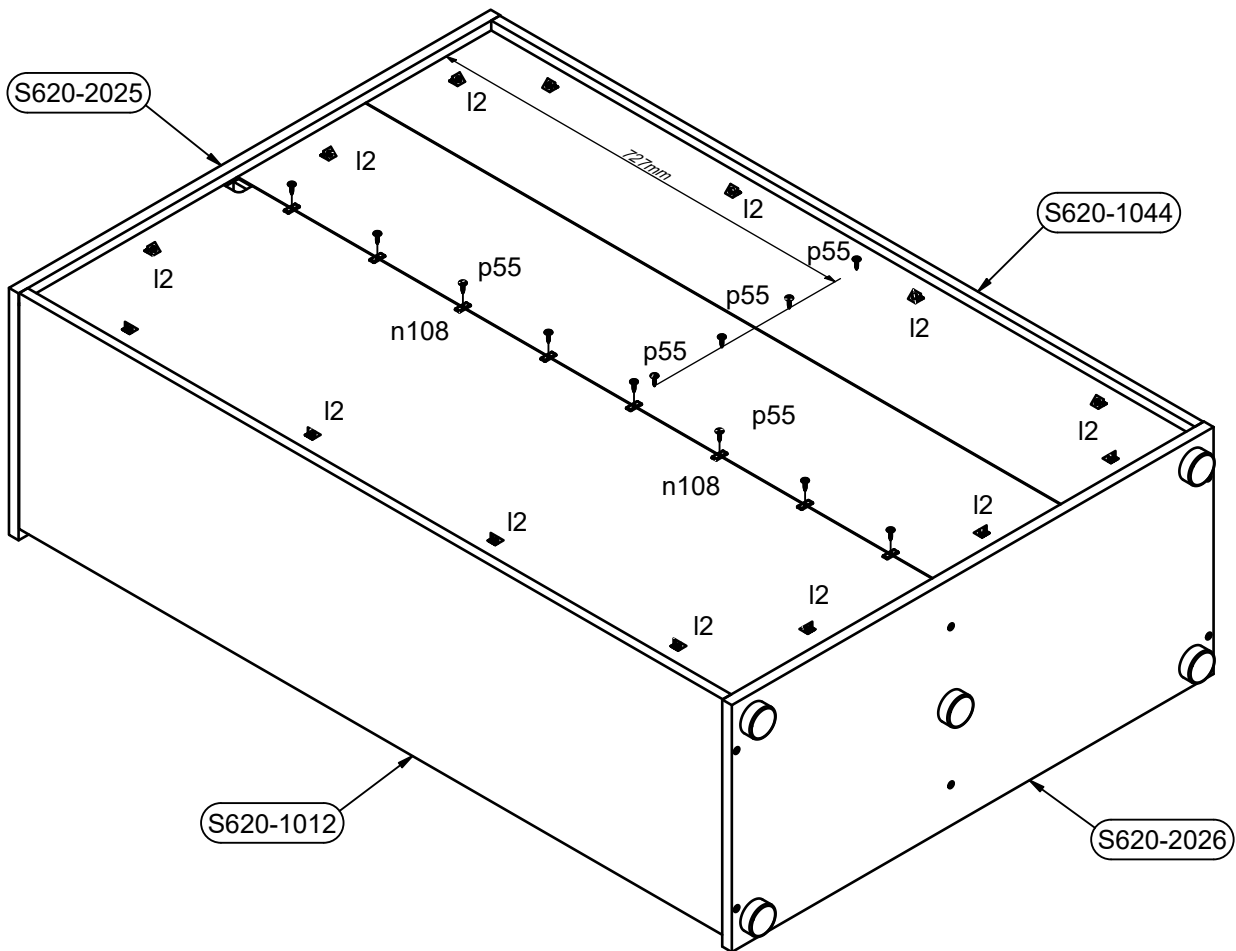
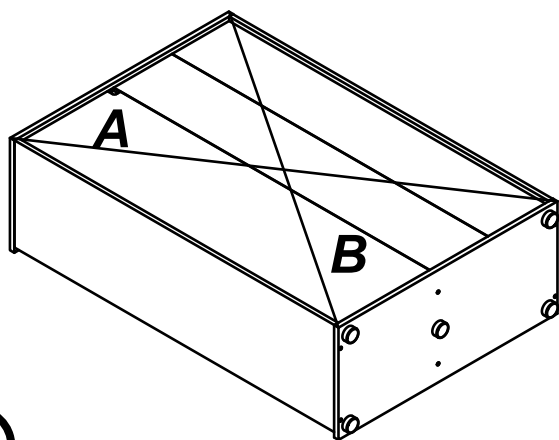
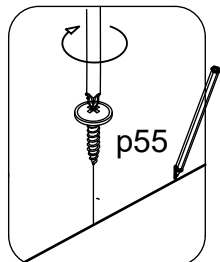
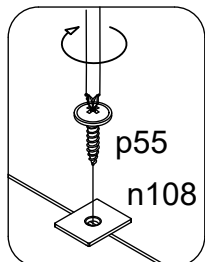

l2		14x	n108		8x	p55		2.8x16mm	8x
----	--	-----	------	--	----	-----	--	----------	----



A=B

12

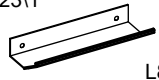
13

s68  ∅20mm	6x	c623\1  L84/64mm	1x	p140  ∅3.5x12 mm	2x	d4  ∅6.3x15 mm	2x
---	----	--	----	---	----	---	----

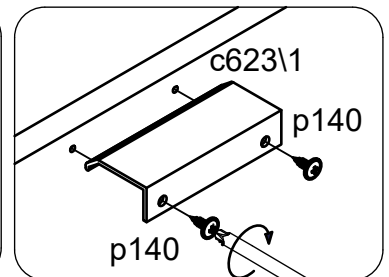
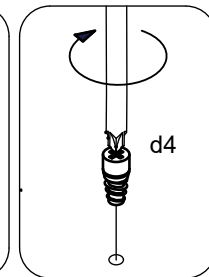
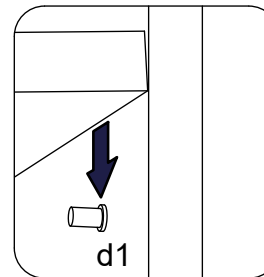
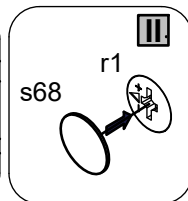
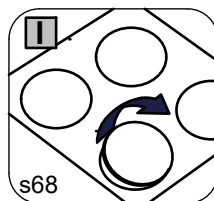
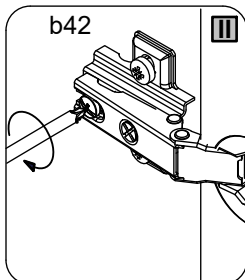
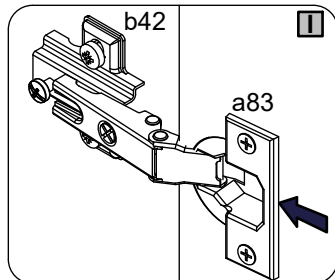
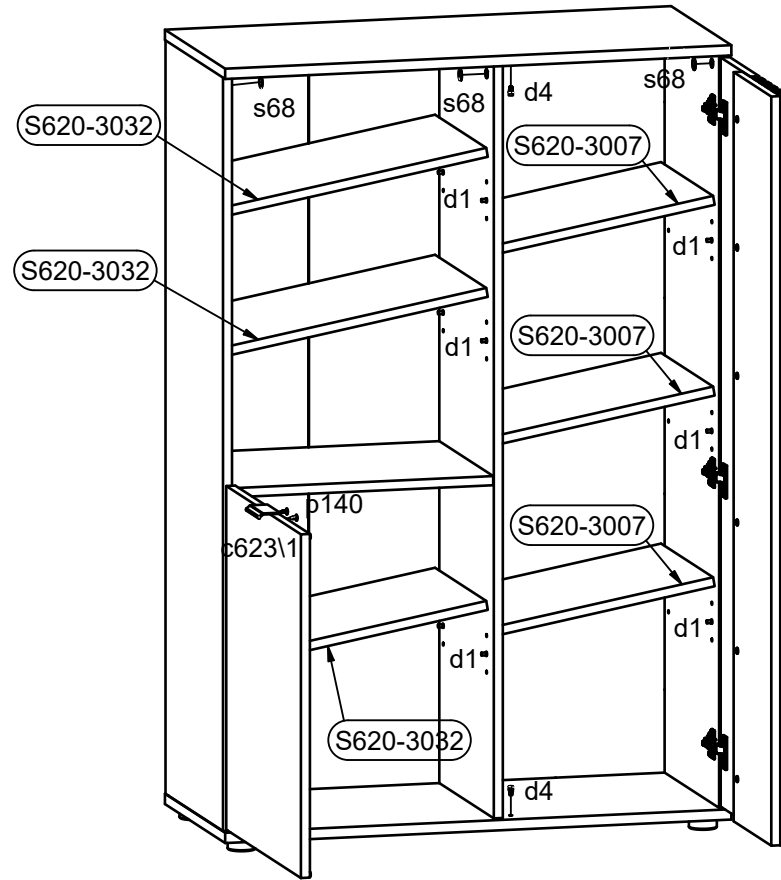
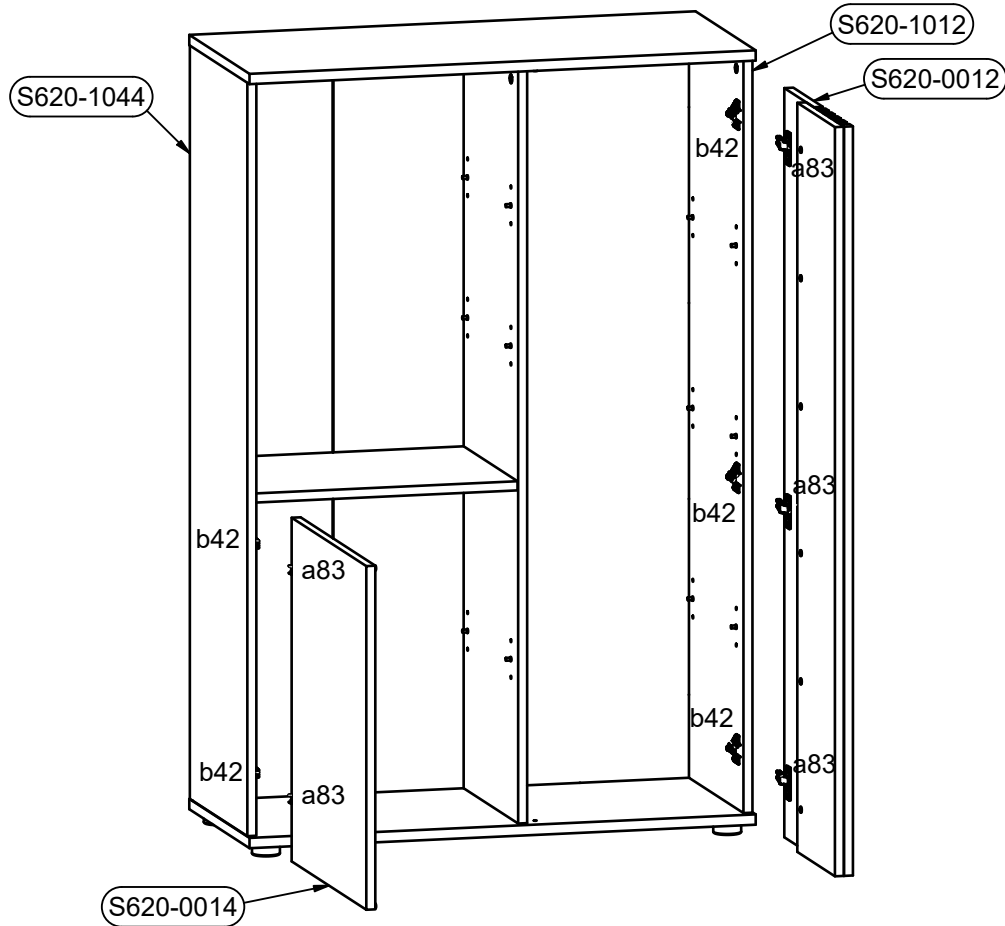

14

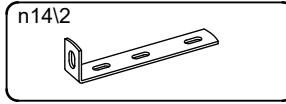

1x

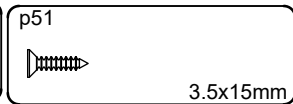

2x



2x

