

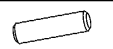



A	B	C1	C2	C3	D
1	M247-0001	1969	636	16	2/2
2	M247-1001	1943	370	15	1/2
3	M247-1002	1943	370	15	1/2
4	M247-2001	640	370	15	1/2
5	M247-2002	640	370	15	1/2
6	M247-3001	609	350	15	1/2
7	M247-3002	608	350	15	1/2
8	M247-9301	1953	619,	2,5	2/2



4x a83	4x <sup>05</sup> b42	1x c25318
16x Ø5x17 mm d1	4x Ø7x50 mm e1	12x Ø8x30 mm f1
2x 151x61x25 mm k54	2x k5511	5x l1
12x l2	1x L=300 mm m6	2x Ø4x30 mm p9
10x Ø4x30 mm p21	4x Ø3,5x13 mm p27	8x Ø3,5x15 mm p51
8x Ø15x12 mm #16 r1	8x 20/11 r42	8x Ø16 s2
1x z1	2x Ø5 s4	

2x Ø10x50 mm f35	2x 88x21x191,5 n1412	2x Ø5x60 mm p17	4x Ø3,5x16 mm p38
------------------------	----------------------------	-----------------------	-------------------------

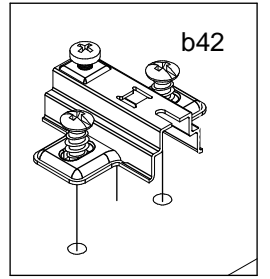
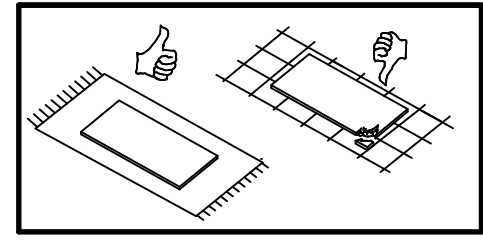
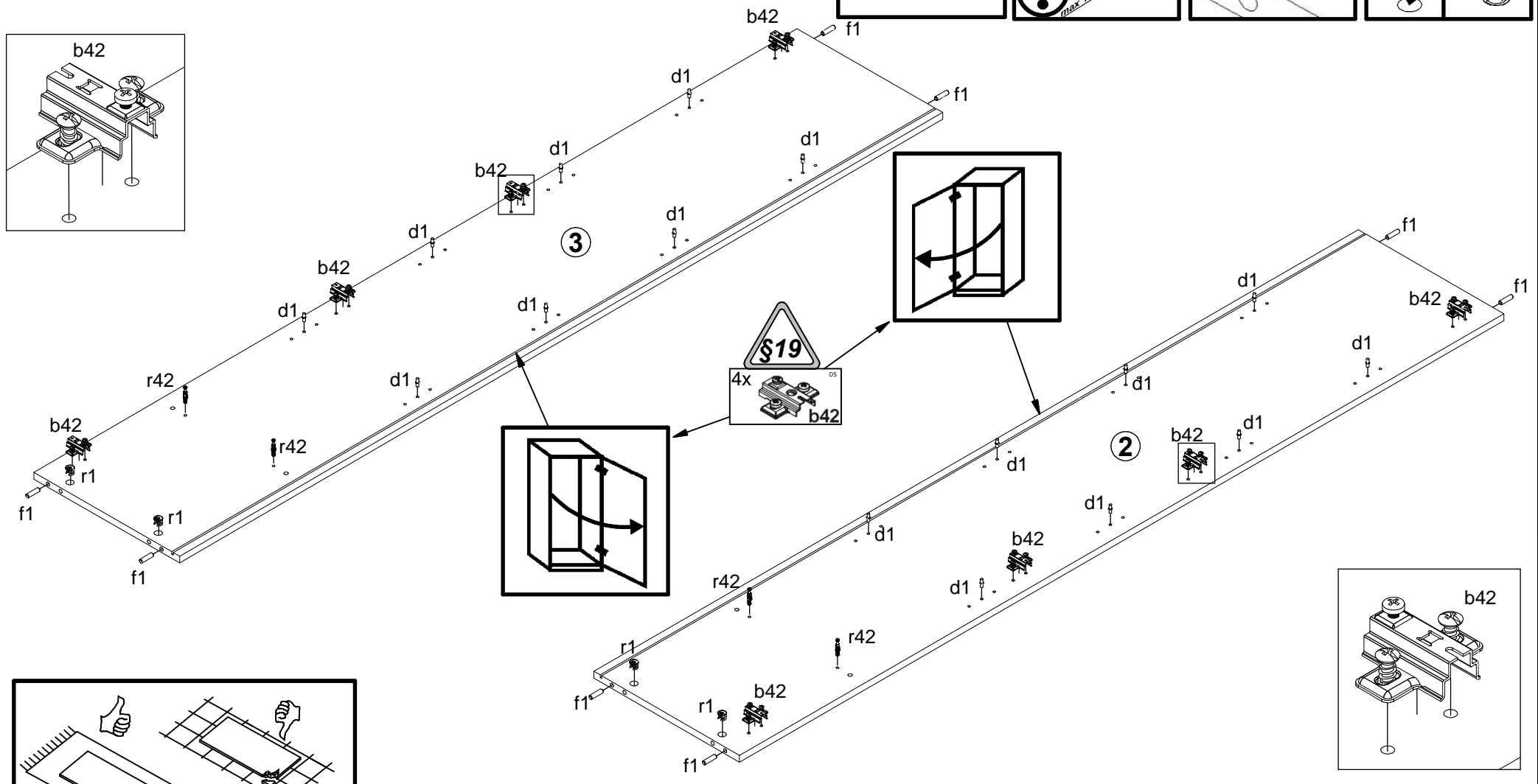
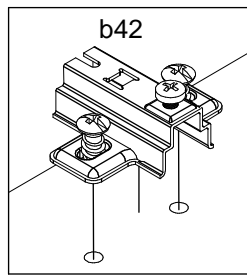
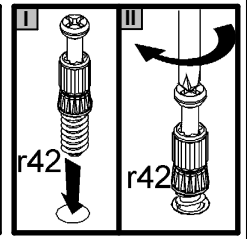
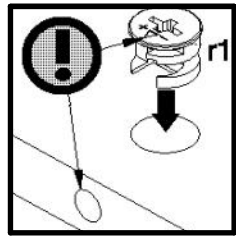
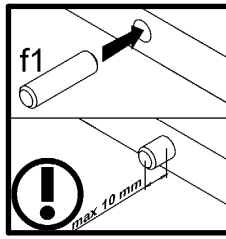
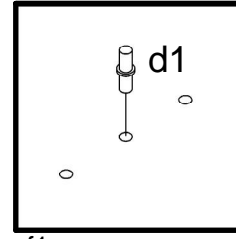

- 4x  f1 Ø8x30 mm
- 2x  r1 Ø15x12 mm #16
- 8x  d1 Ø5x17 mm
- 2x  r42 20/11

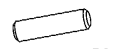

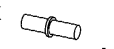
- 4x  f1 Ø8x30 mm
- 2x  r1 Ø15x12 mm #16
- 2x  r42 20/11
- 8x  d1 Ø5x17 mm

1

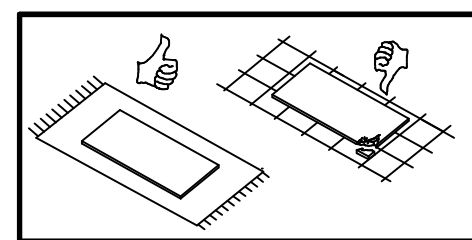
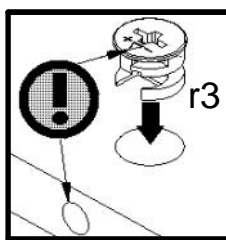
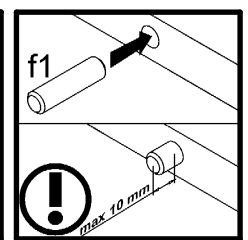
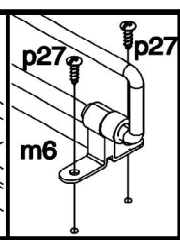
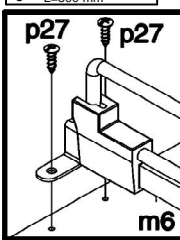
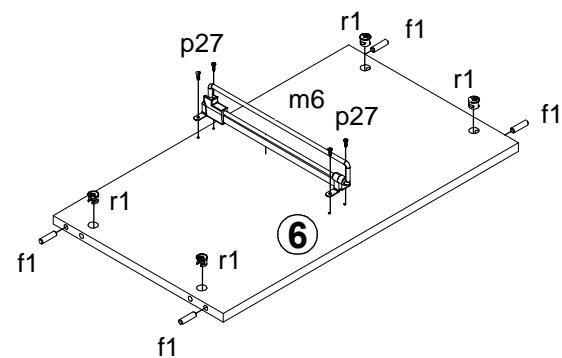
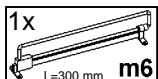
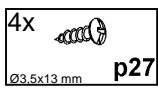
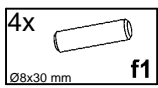
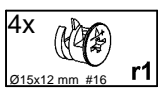
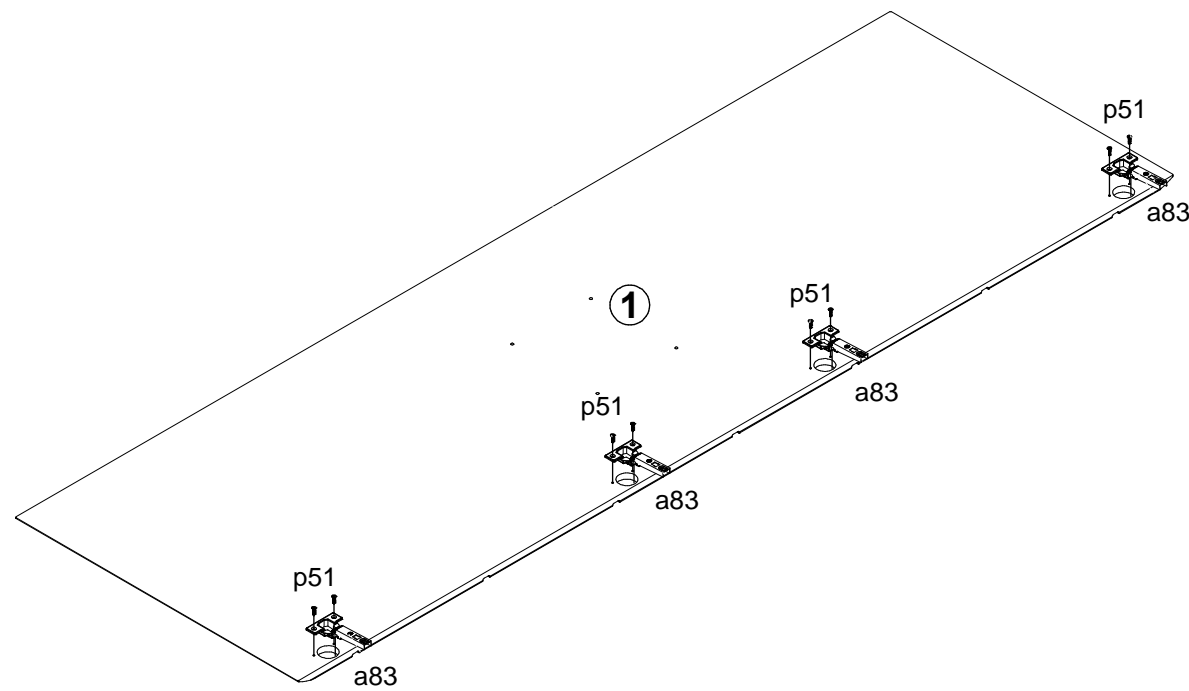
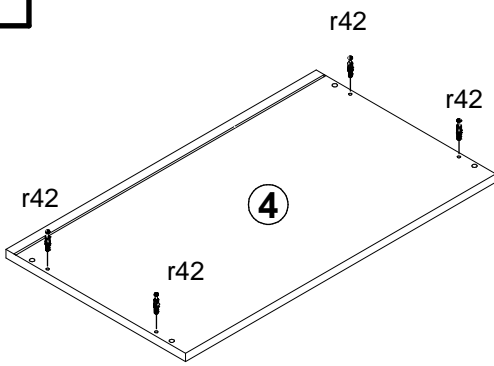
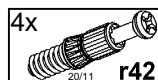
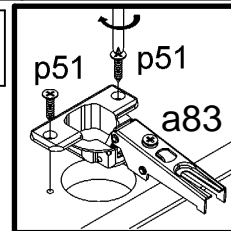
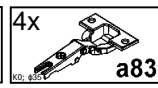
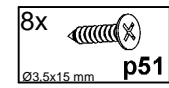
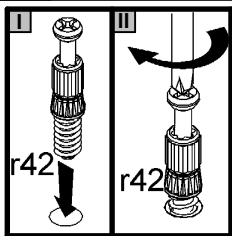

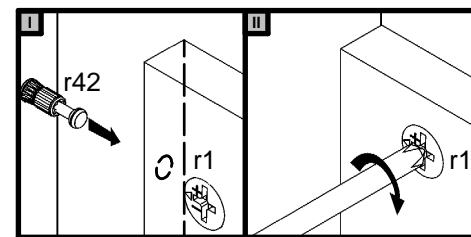
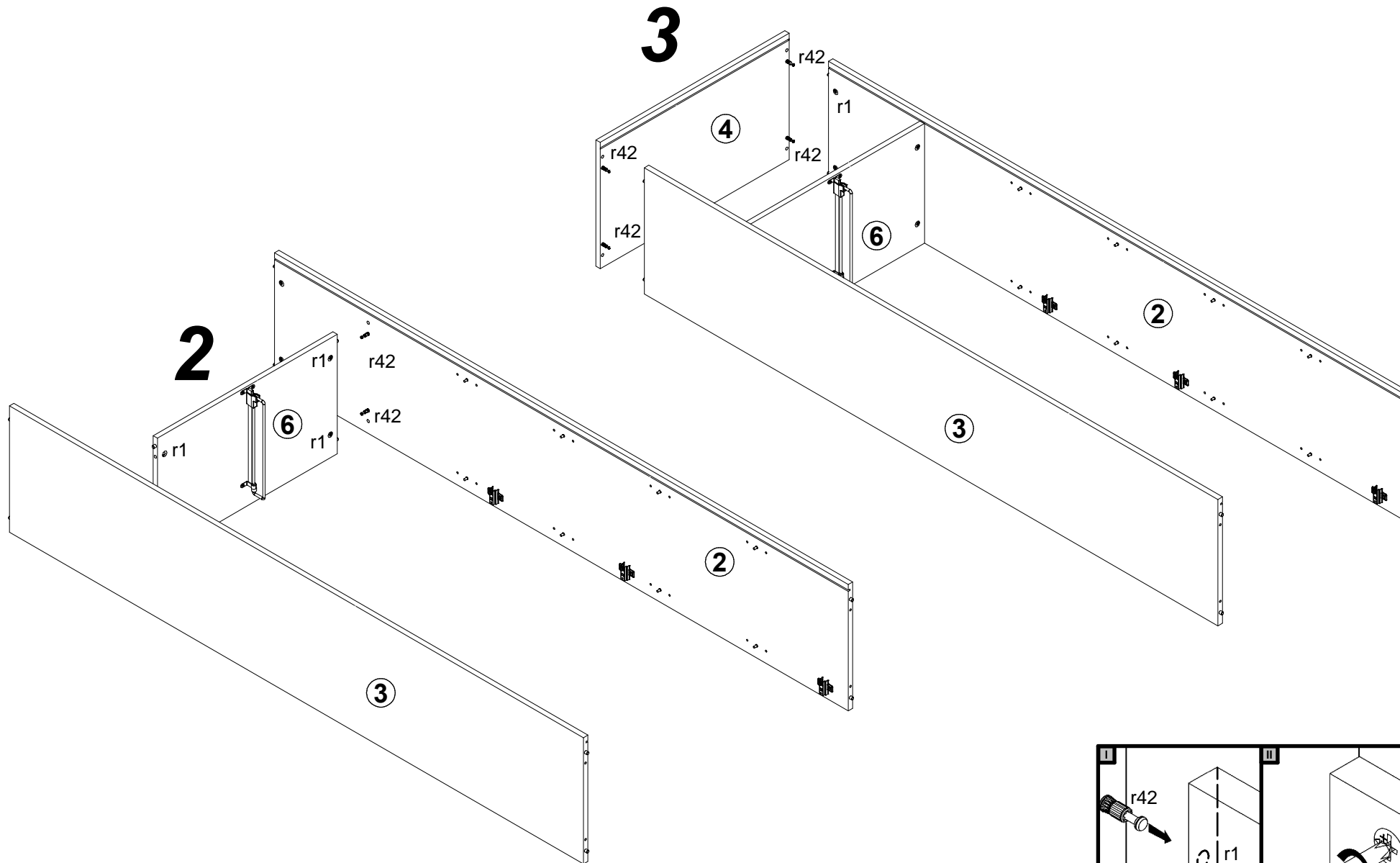

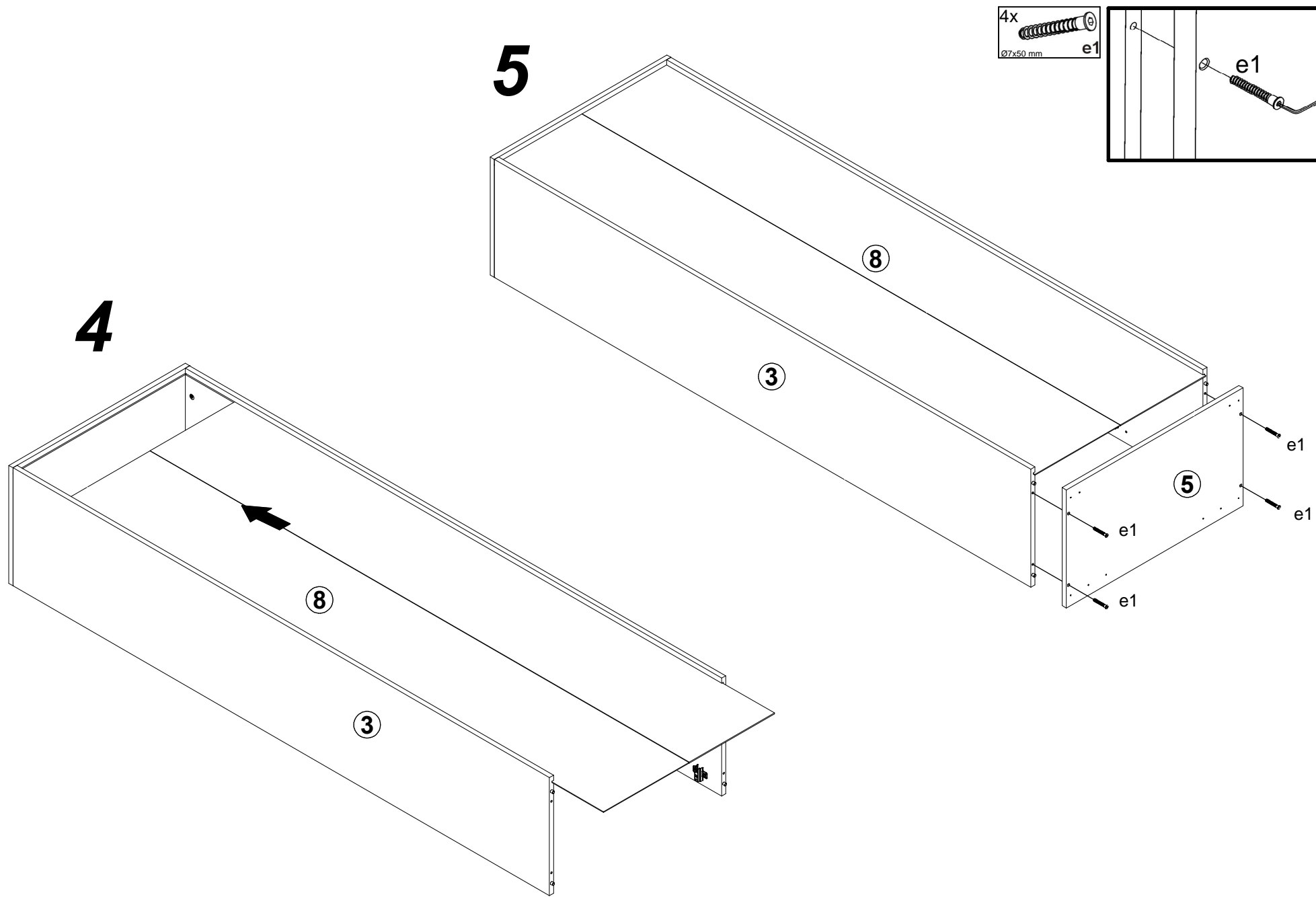

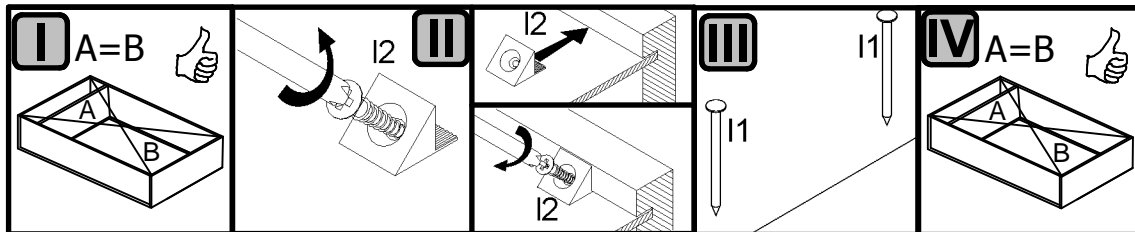



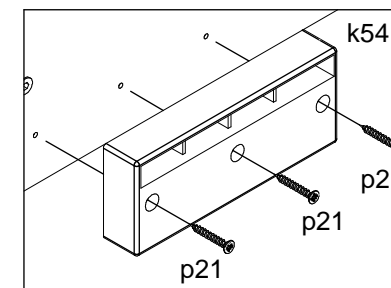
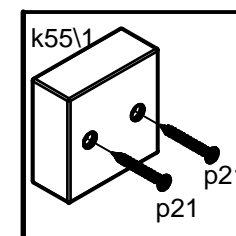
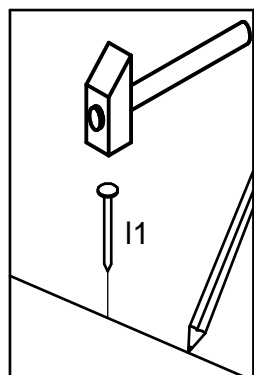
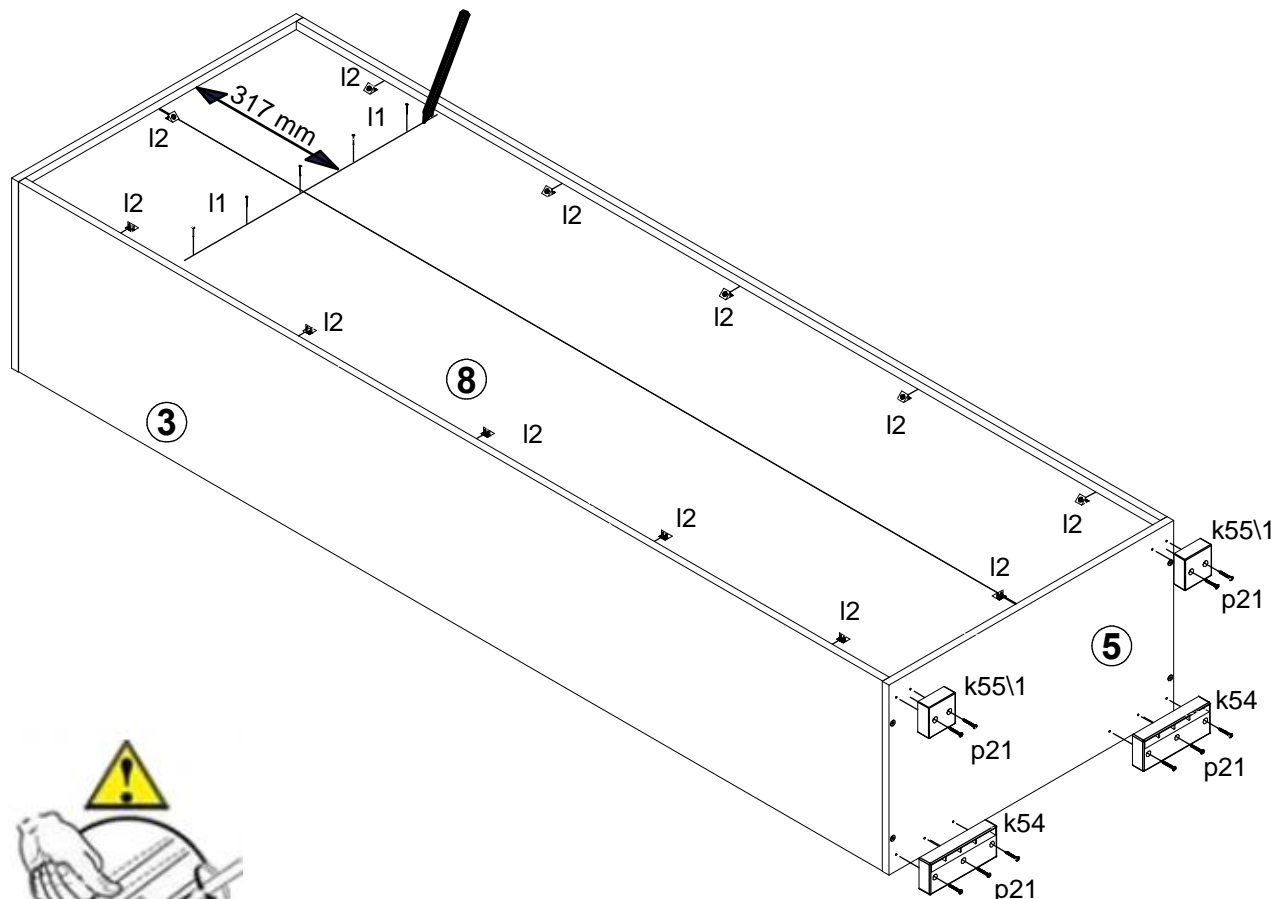

- 10x p21  
Ø4x30 mm
- 2x k54  
151x61x25 mm
- 2x k55\1
- 12x l2
- 5x l1

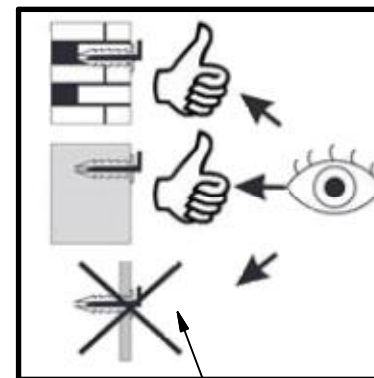
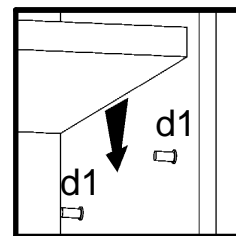
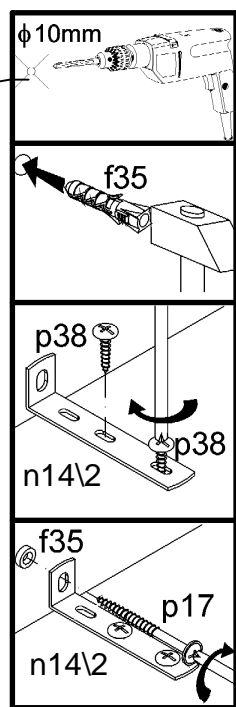
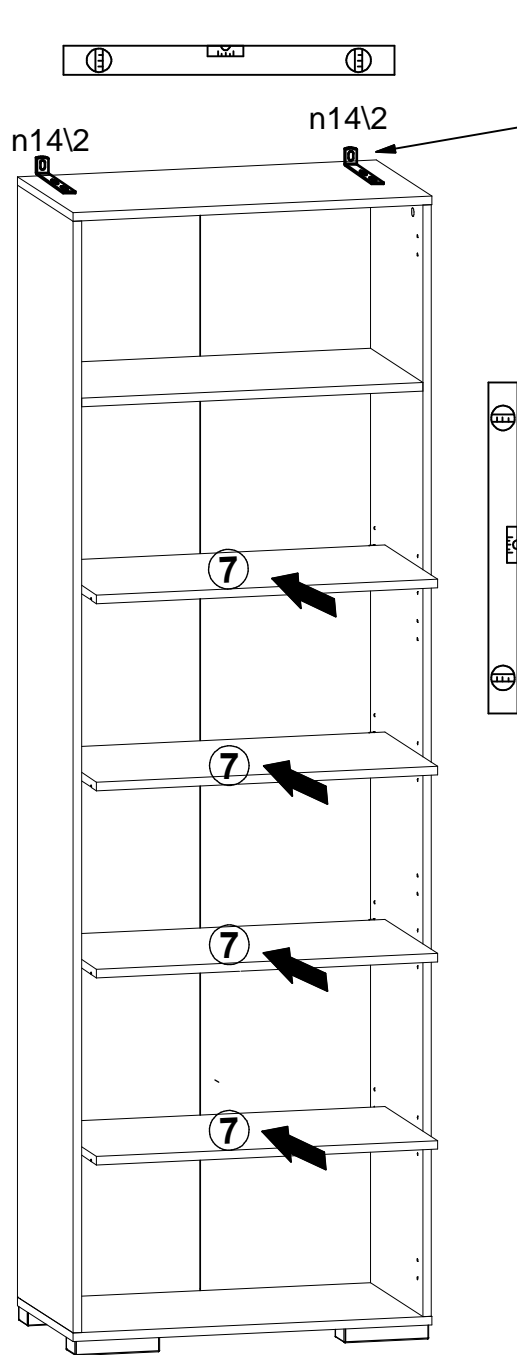

9

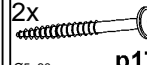

-   
 2x  
 Ø10x50 mm f35
-   
 2x  
 86x21x15/1.5 n14\2
-   
 2x  
 Ø5x60 mm p17
-   
 4x  
 Ø3.5x16 mm p38



7

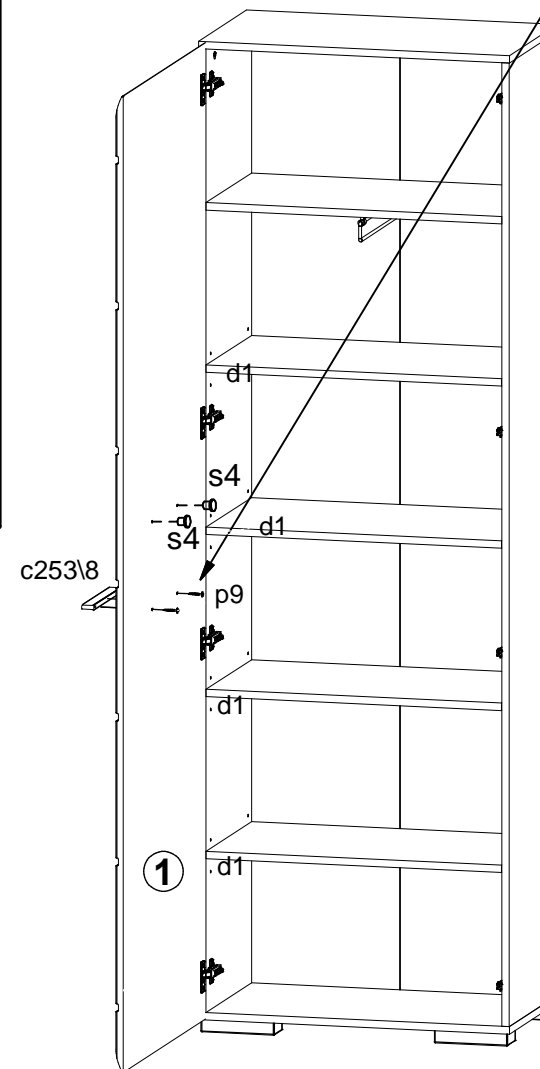
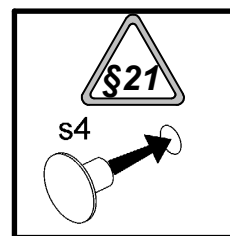
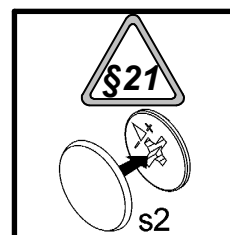
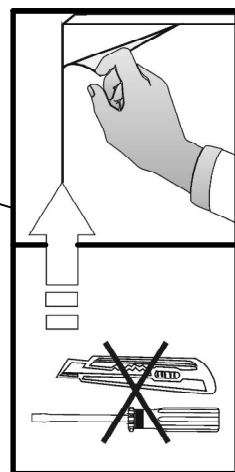
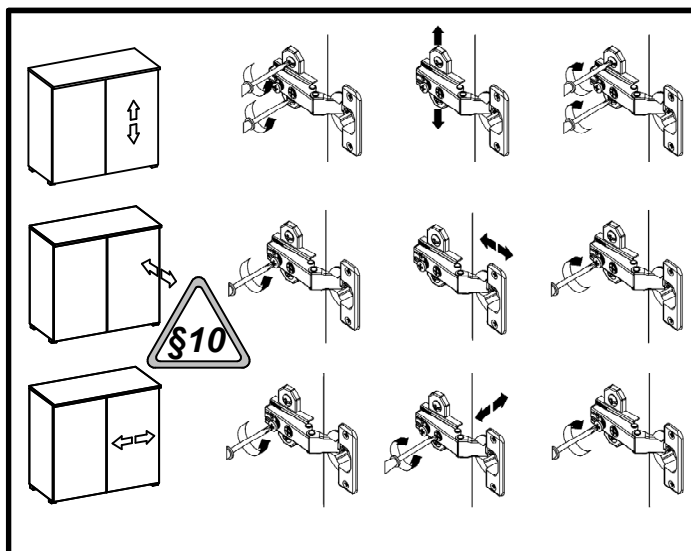
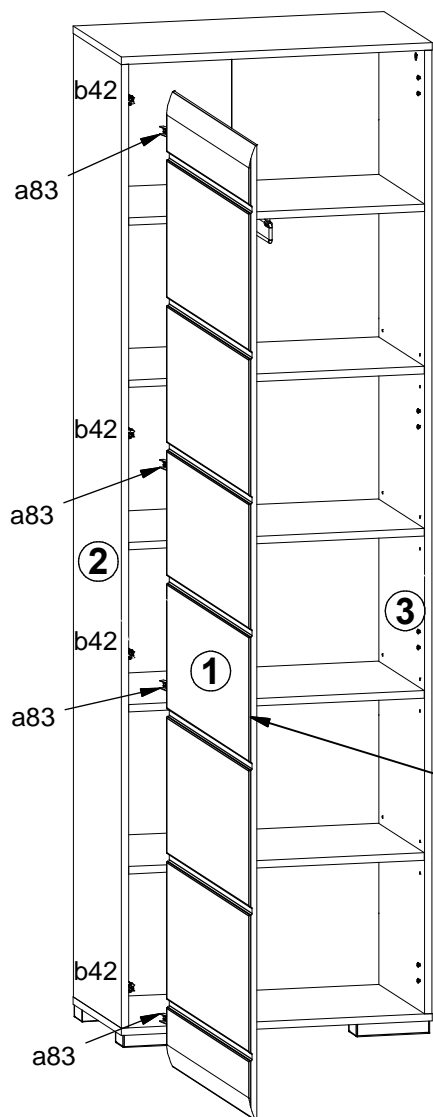
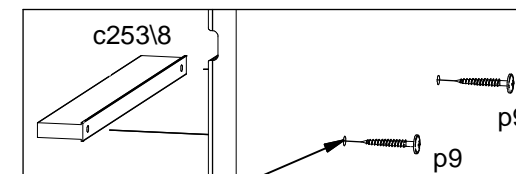
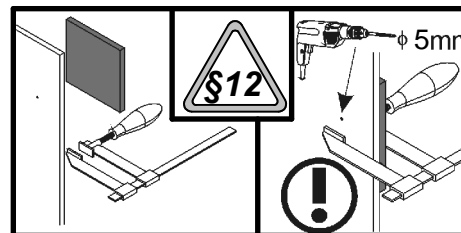
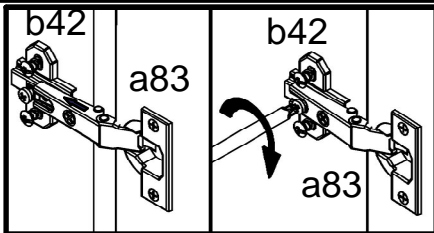

8

