

A**FLEX****F57-FRN-220/218/SZK-Z**

A	B	C	D
1	F57-0086	1098	696
2	F57-0087	1098	696



3		1098	696	1/1
---	--	------	-----	-----

4	w108\3	2090	-	1/2
5	Eg-sp_2090	2090	-	2/2

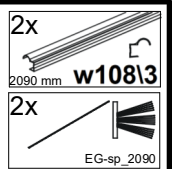
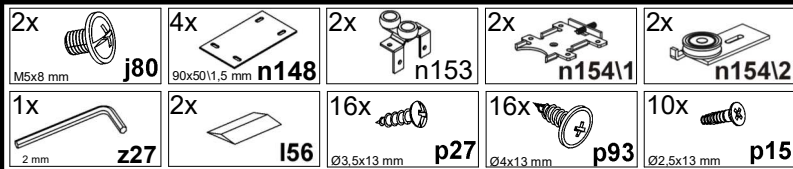
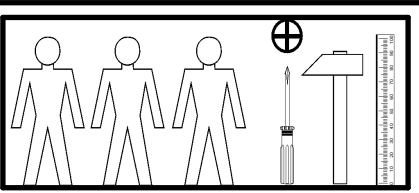
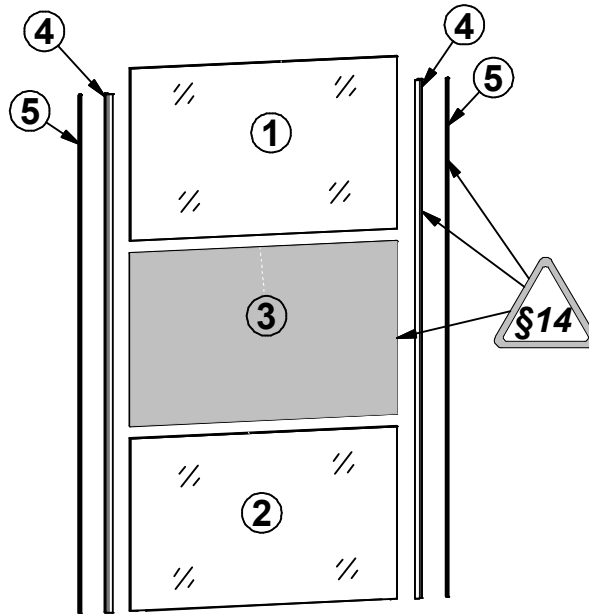

1 §2 §6 §11

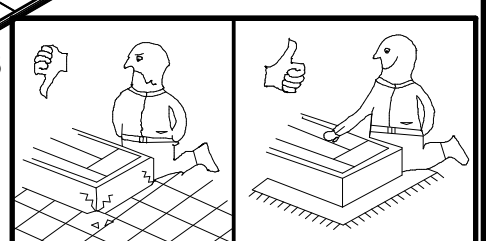
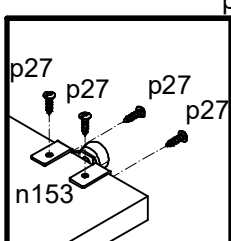
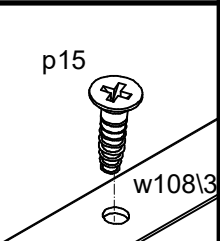
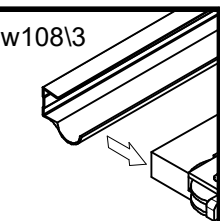
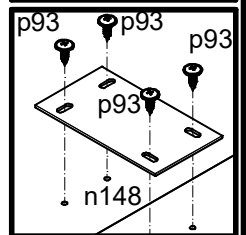
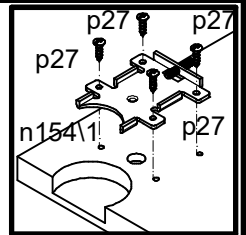
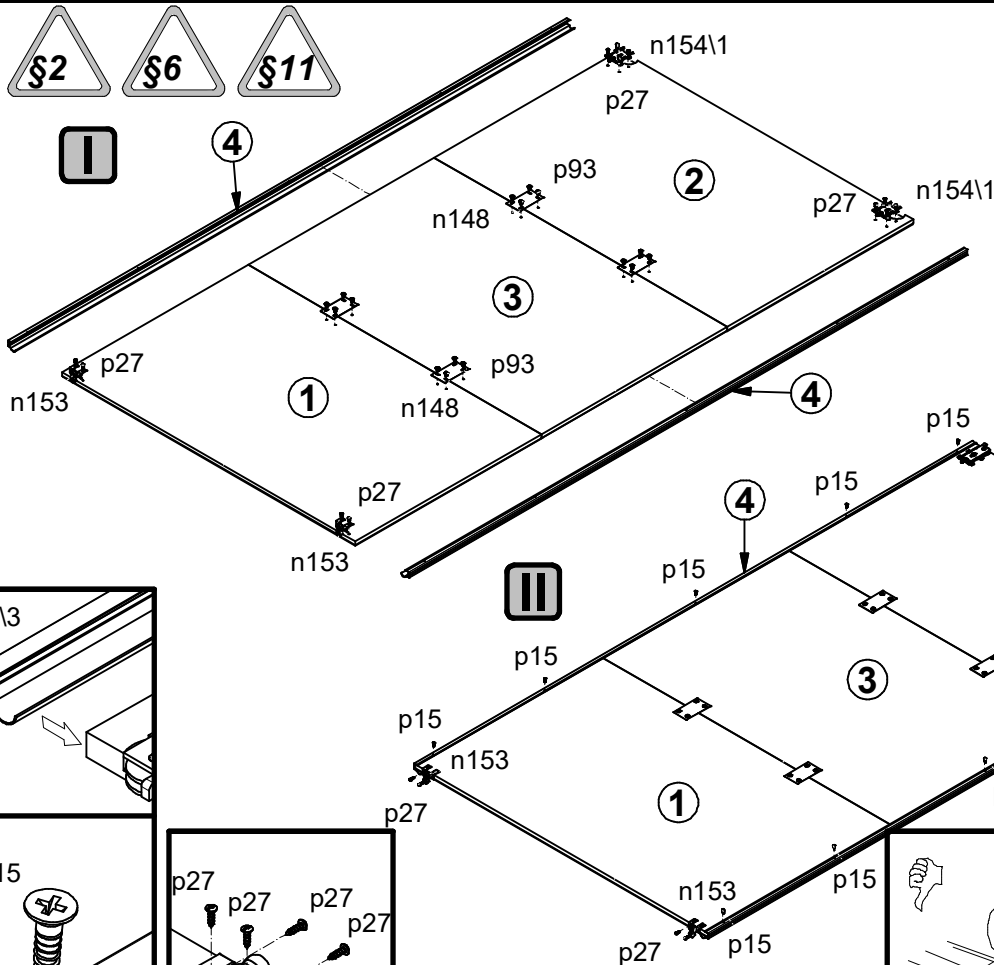

2

