

# CAPS

## S153-BIU/120

A	B	C	D	A	B	C	D		
1	S153-008	365	188	1/3	10	S153-403	738	360	1/3
2	S153-010	455	365	1/3	11	S153-404	652	385	1/3
3	S153-114	728	579	1/3	12	S153-578	186	49	3/3
4	S153-115	728	579	1/3	13	S153-579	335	49	3/3
5	S153-116	728	579	1/3	14	S153-908	332	498	2/3
6	S153-205	1200	600	2/3	15	ZS2-509	500	120	2/3
7	S153-311	385	563	2/3	16	ZS2-510	500	120	2/3
8	S153-314	713	385	1/3	17	ZS2-5559	321	120	2/3
9	S153-325	384	524	1/3					

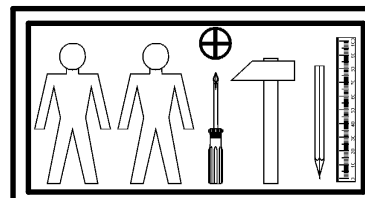
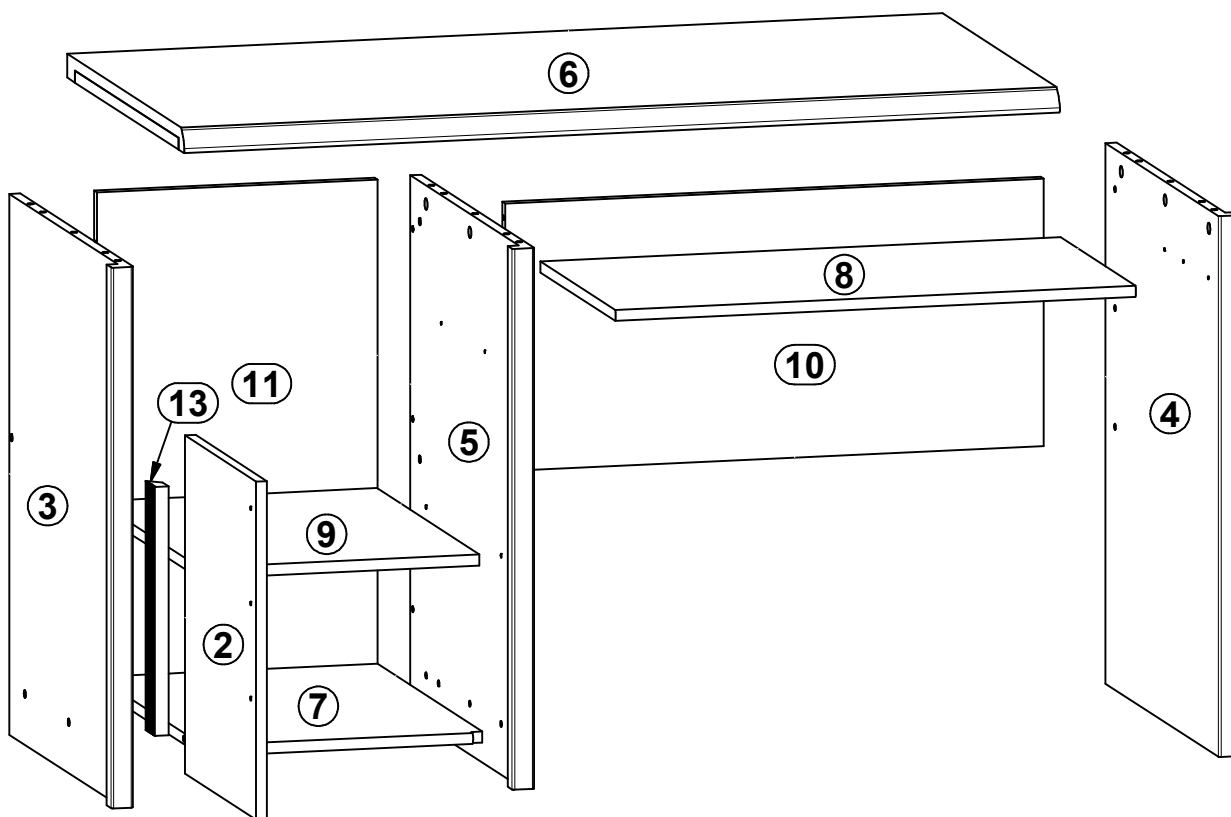
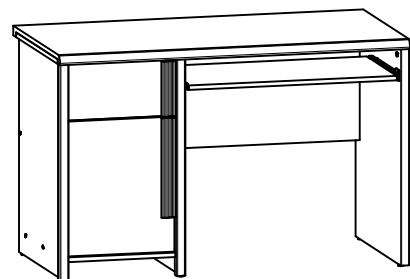

2x K16 a43	2x b19	4x φ5x17 mm d1	12x φ7x50 mm e1	6x φ5x9 mm e19	4x φ6,3x13 mm e2	3x φ6x28 mm e25	9x φ6x13 mm e3	16x φ8x30 mm f1
4x φ6,5x40 mm f25	6x k1	4x φ3,5x13 mm p27	4x φ3,5x15 mm p51	5x φ4x22 mm p60	9x φ1,5x12mm #16 r1	4x φ12x10,5mm #12 r15	13x r42	1x 500 mm w26\CL
1x 500 mm w26\CR	1x 500 mm w26\DL	1x 500 mm w26\DR	1x 350 mm w45\CL	1x 350 mm w45\CR	1x 350 mm w45\DL	1x 350 mm w45\DR	3x h=16 mm w47	11x s1
5x ø16 s2	1x z1							

1 

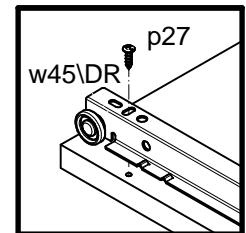
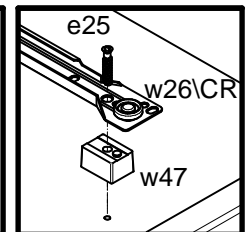
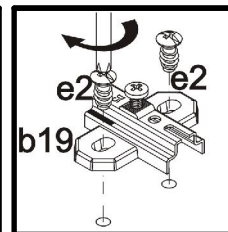
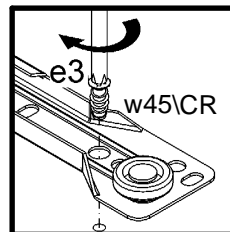
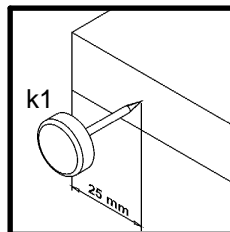
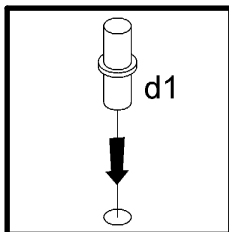
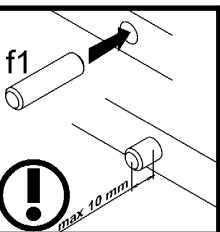
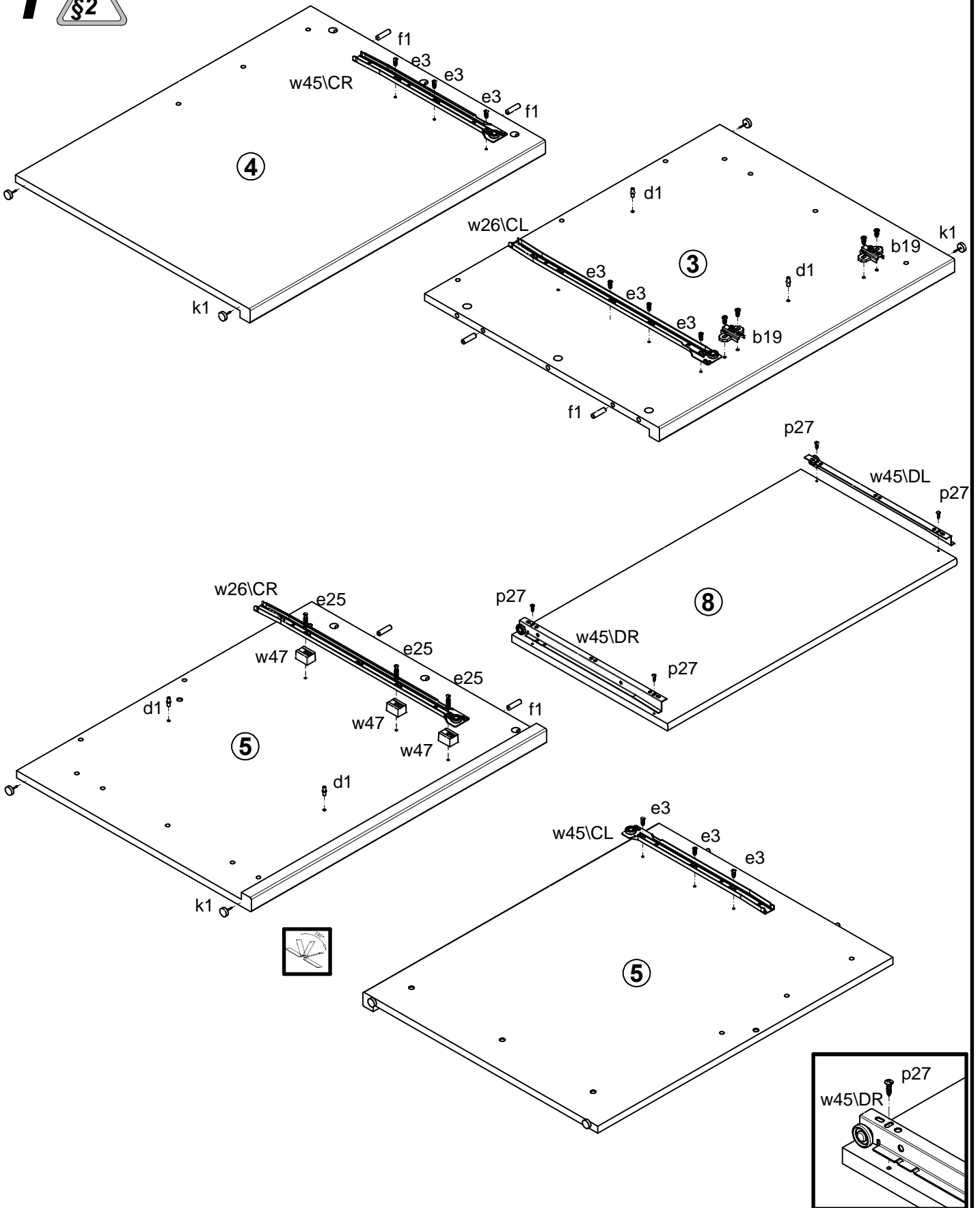

# 2

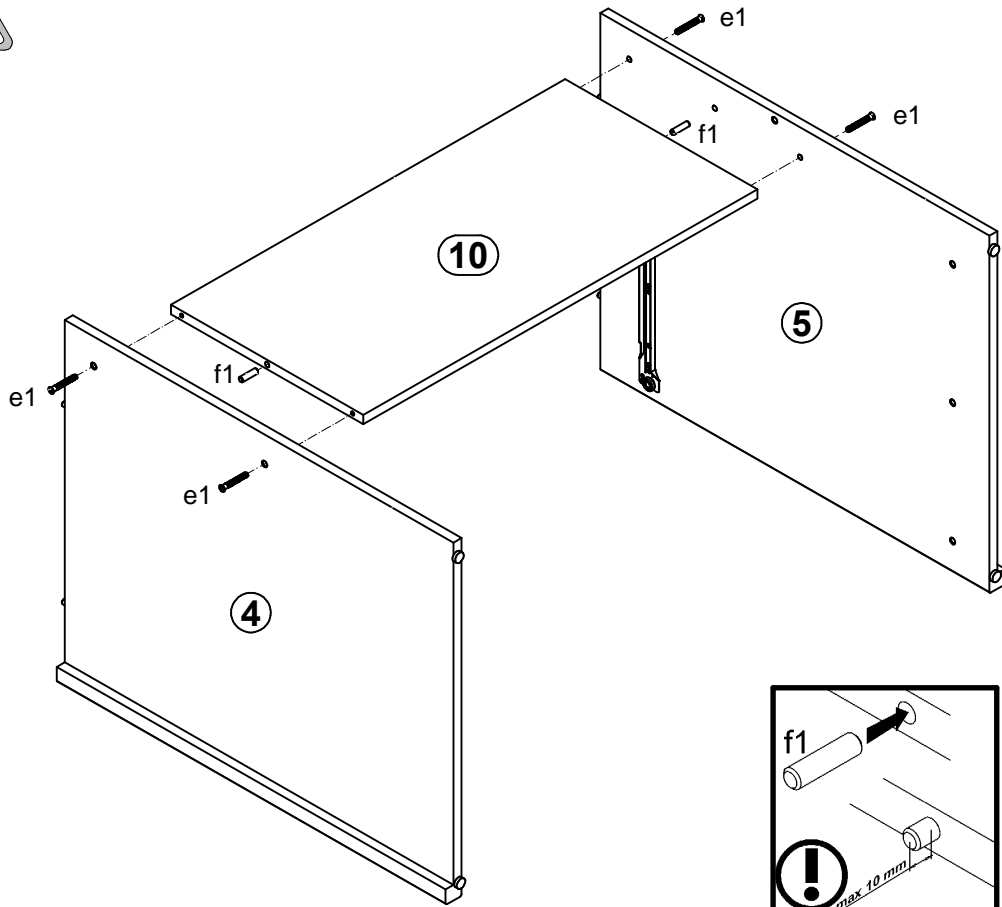

# 3

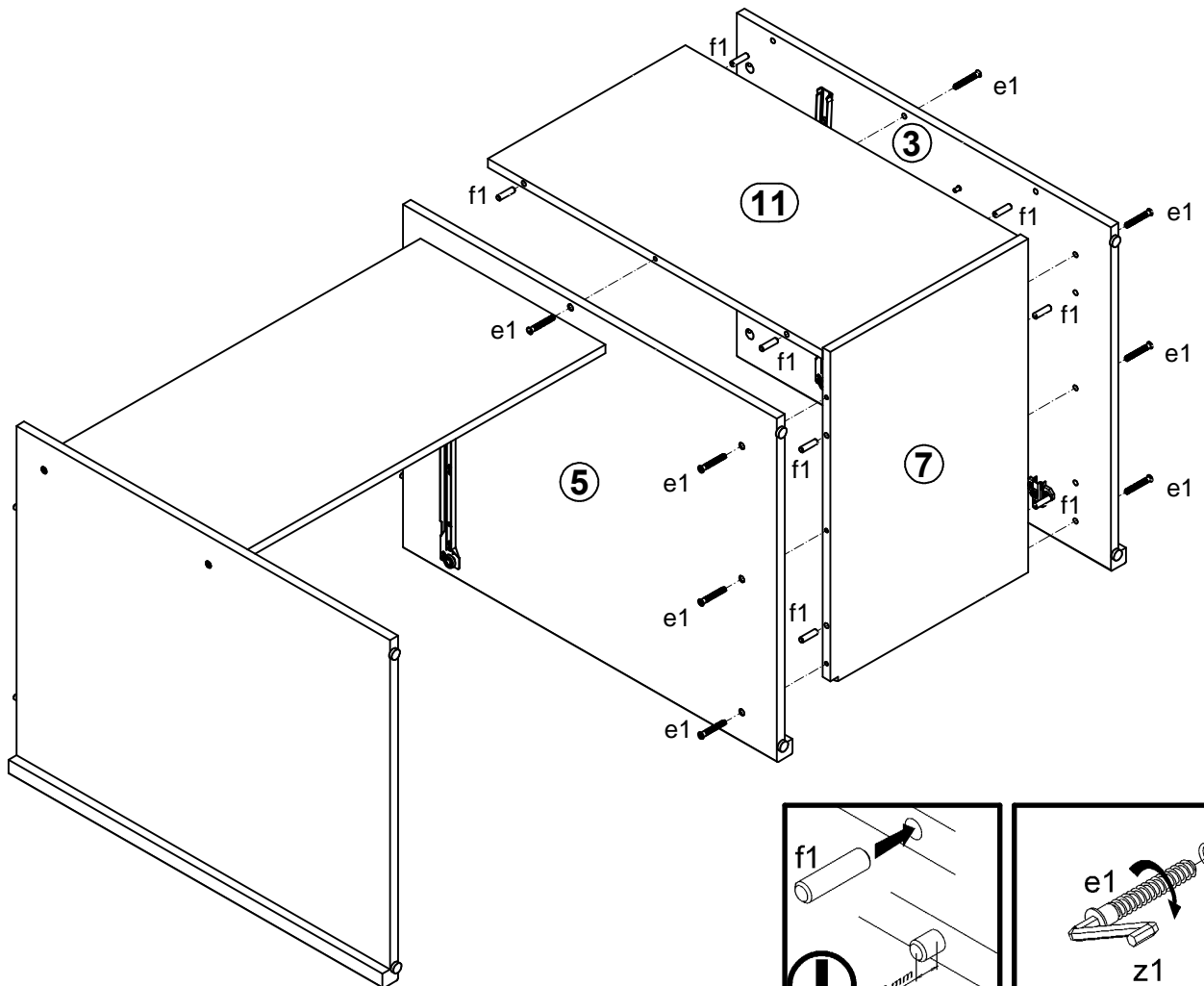

# 4

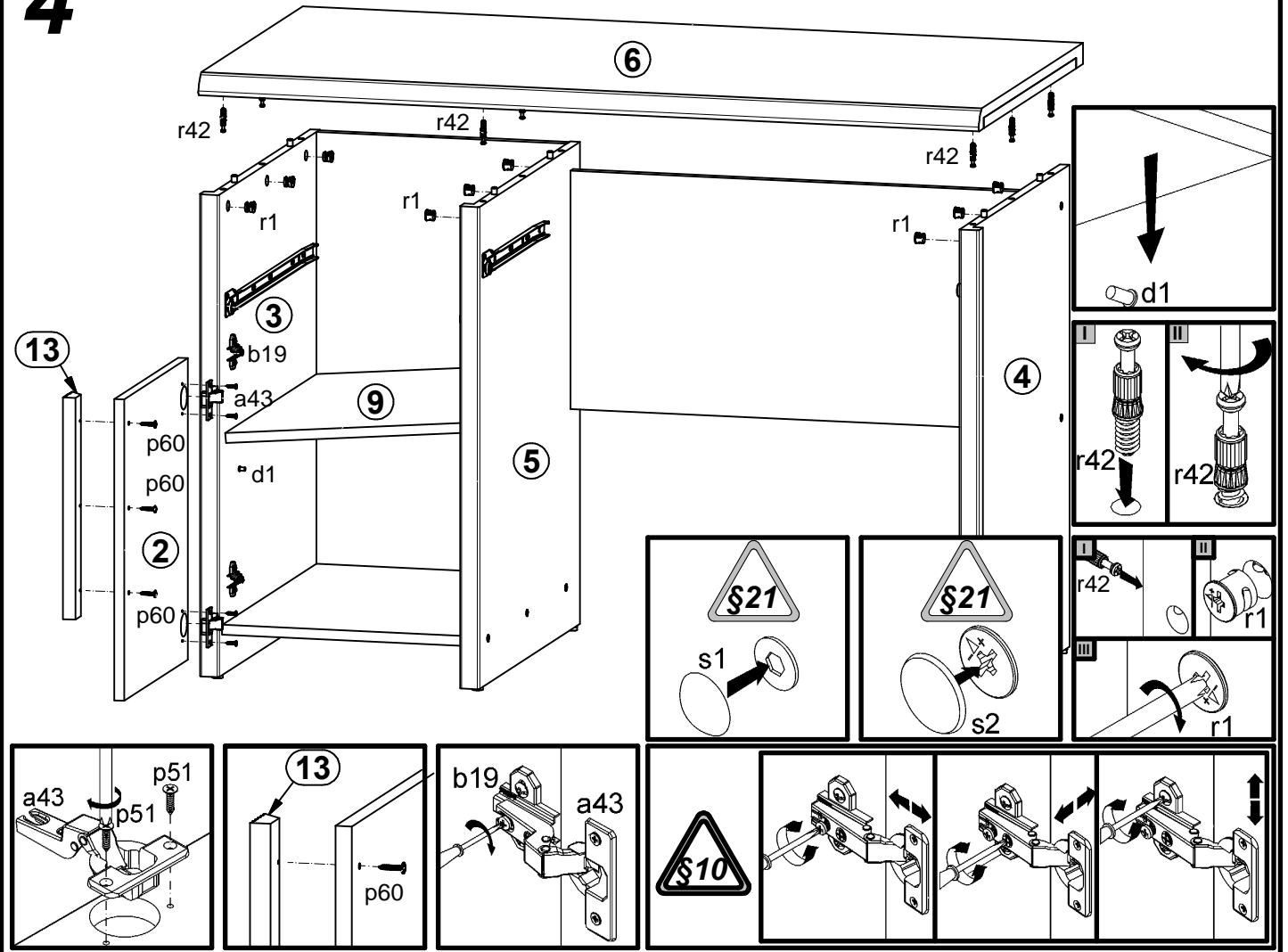

# 5

