

A	B	C	D	
1	S311-001	446	1934	5/5
2	S311-104	1922	380	1/5
3	S311-105	1922	380	1/5
4	S311-202	652	402	2/5
5	S311-203	652	402	2/5
6	S311-302	620	380	2/5
7	S311-303	619	379	2/5
8	S311-502	1942	100	3/5
9	S311-503	1942	100	3/5
10	S311-552	618	374	4/5
11	S311-902	1949	645	1/5

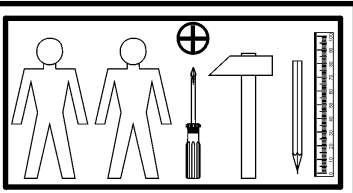

3x  a99	3x  b43	1x  128mm c392	4x  Ø5x17 mm d1	8x  Ø5x17 mm d3	6x  Ø6.3x13 mm e2	8x  Ø6x22 mm e31	8x  Ø5x12 mm e41	20x  Ø8x30 mm f1
4x  k87	60x  l1	4x  25x25x16±2 n110	6x  Ø3.5x15 mm p51	2x  Ø4x25 mm p87	24x  Ø15x12 mm #16 r1	24x  r42	1x  Ø3.5x16 mm p38	1x  n2611
18x  Ø16 s2								

# 1

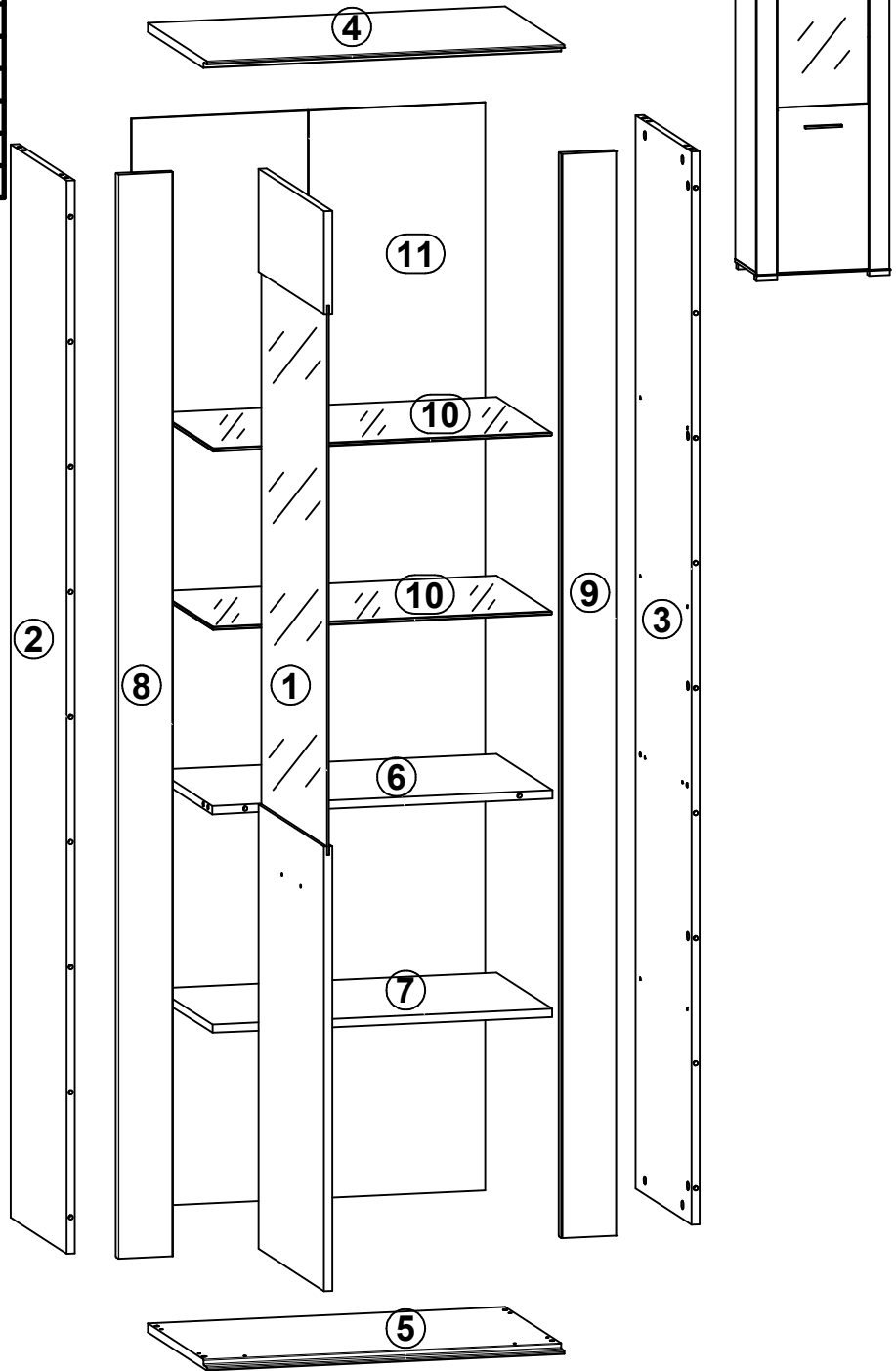
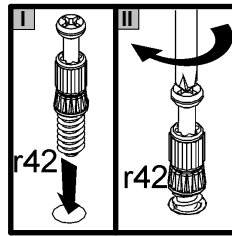
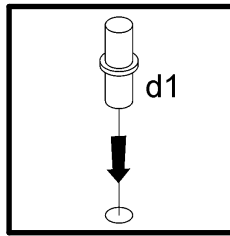
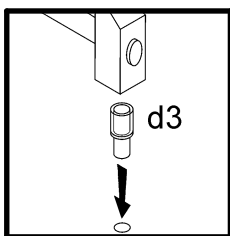
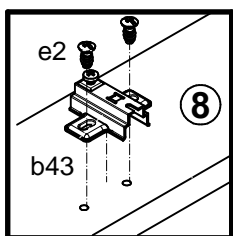
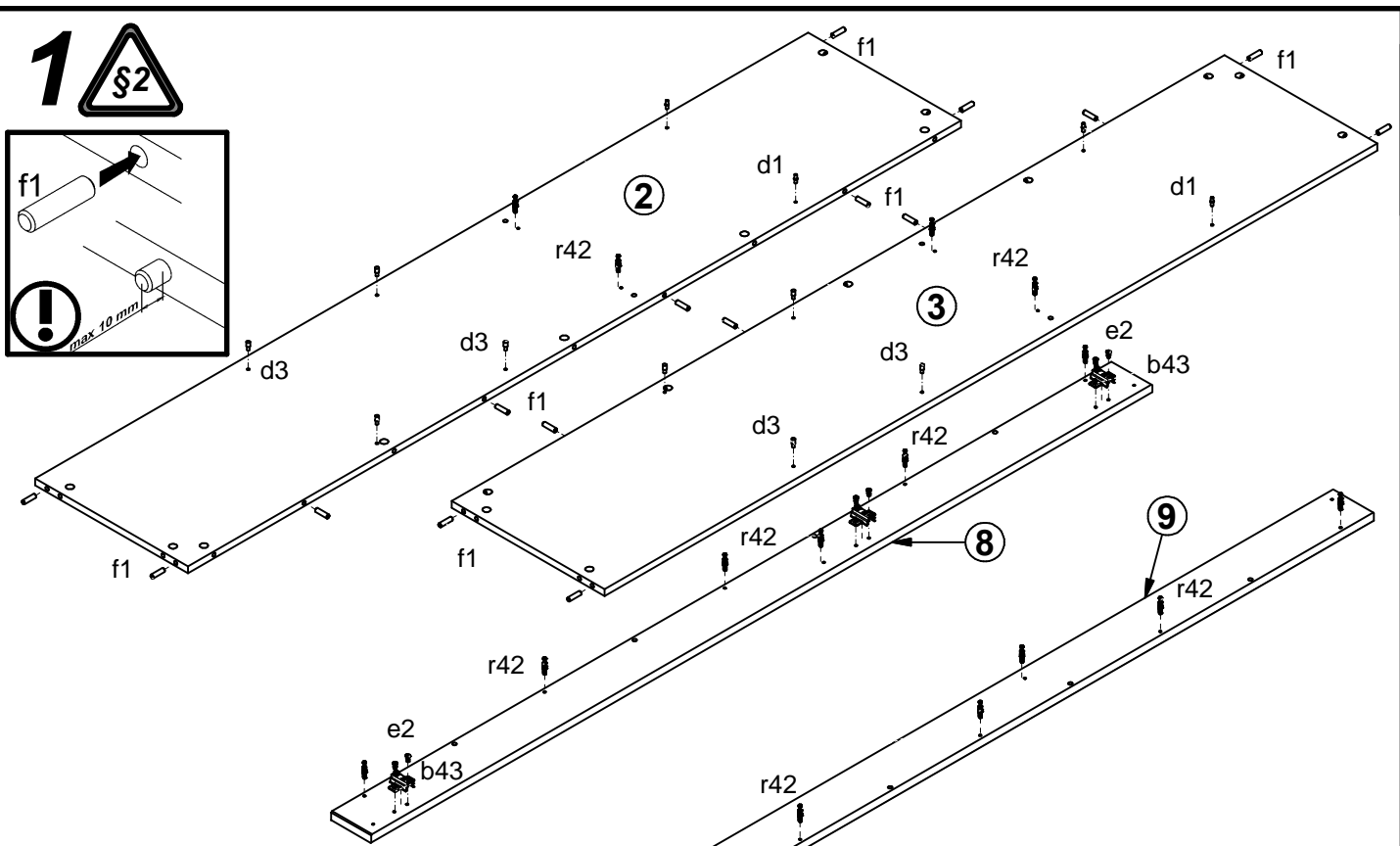
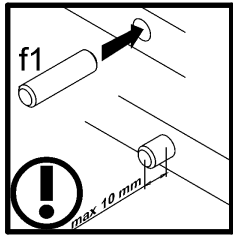

# 2

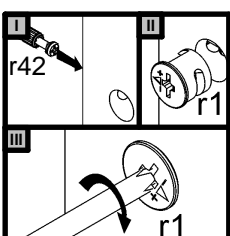
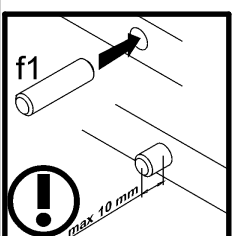
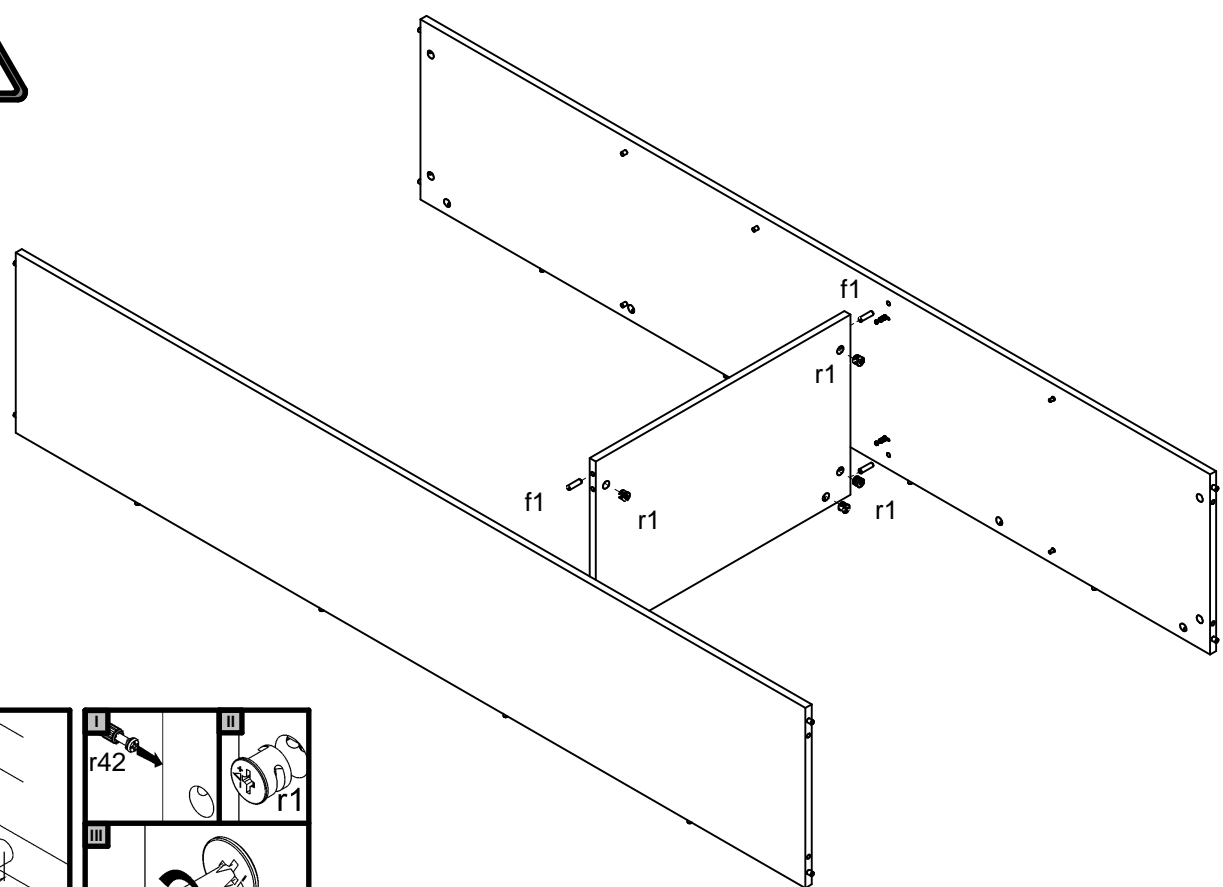

# 3

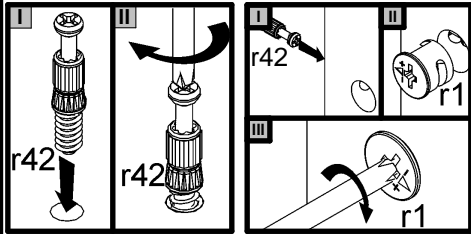
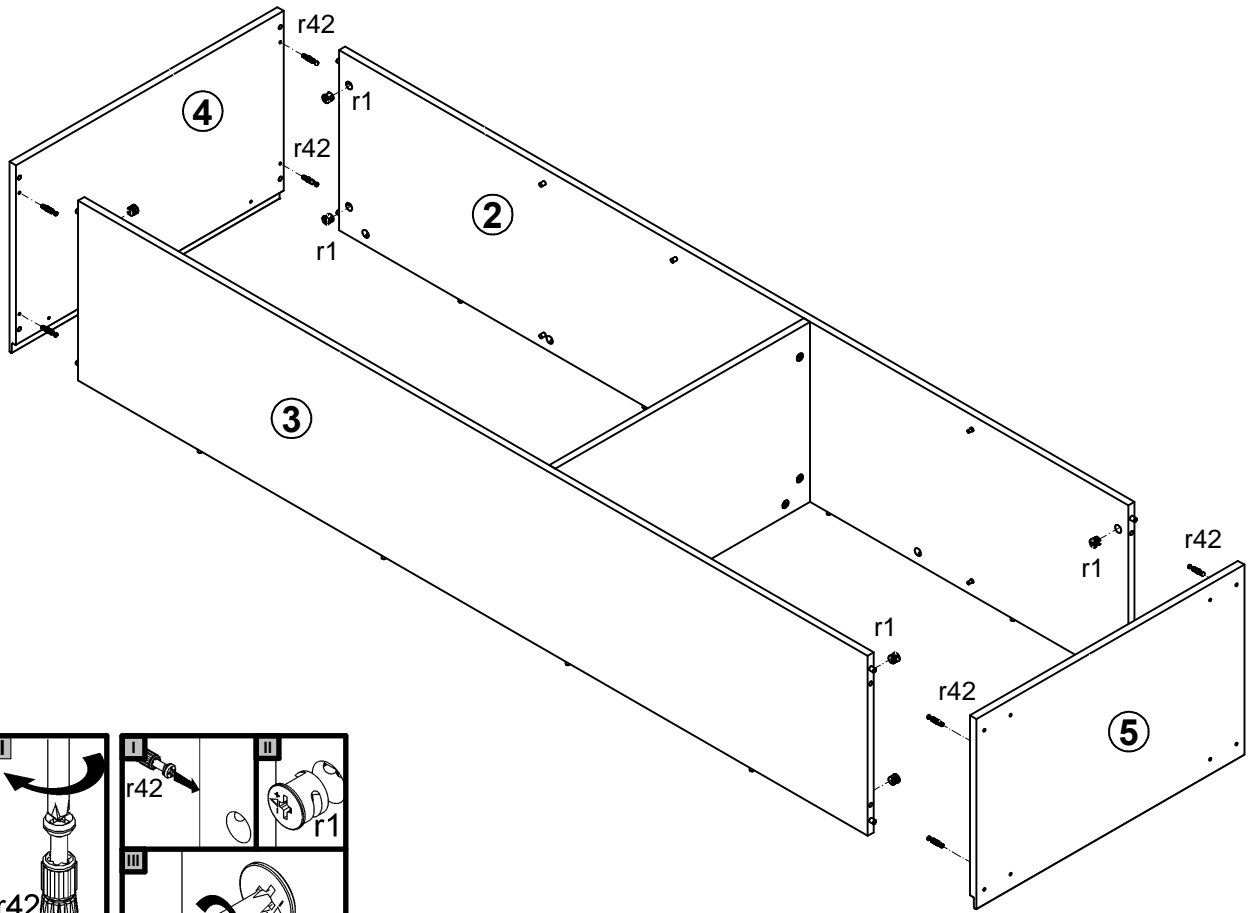

# 4

